

Model HVM100

Human Vibration Meter

Manual



Larson Davis HVM100

Manual

Copyright

Copyright 2006-2015 by PCB Piezotronics, Inc. This manual is copyrighted, with all rights reserved. The manual may not be copied in whole or in part for any use without prior written consent of PCB Piezotronics, Inc.

ICP[®] is a registered trademark of PCB Group, Inc. Blaze[®] is a registered trademark of PCB Piezotronics, Inc. Switchcraft[®] is a registered trademark of Switchcraft, Inc. LEMO[®] is a registered trademark of LEMO SA. LEMO USA[®] is a registered trademark of INTERLEMO HOLDING USA. All other trademarks are property of their respective owners.

Disclaimer

The following paragraph does not apply in any state or country where such statements are not agreeable with local law:

Even though PCB Piezotronics, Inc. has reviewed its documentation, PCB Piezotronics Inc. makes no warranty or representation, either expressed or implied, with respect to this instrument and documentation, its quality, performance, merchantability, or fitness for a particular purpose. This documentation is subject to change without notice, and should not be construed as a commitment or representation by PCB Piezotronics, Inc.

This publication may contain inaccuracies or typographical errors. PCB Piezotronics, Inc. will periodically update the material for inclusion in new editions. Changes and improvements to the information described in this manual may be made at any time.

Record of Serial Number and Purchase Date

HVM100 Purchase Date _____ Serial Number: _____

Recycling

PCB Piezotronics, Inc. is an environmentally friendly organization and encourages our customers to be environmentally conscious. When this product reaches its end of life, please recycle the product through a local recycling center or return the product to:

PCB Piezotronics, Inc.

Attn: Recycling Coordinator

1681 West 820 North

Provo, Utah, USA 84601-1341

where it will be accepted for disposal



Product Warranty

For warranty information, refer to our *Terms and Conditions of Sale* on our website at www.larsondavis.com/TermsConditions.aspx.

Table of Contents

Chapter 1	Introduction	1-1
	About This Manual	1-1
	Accessories	1-3
	Standard Accessories	1-3
	Optional Accessories.....	1-3
	Transducers	1-3
	Calibrator.....	1-3
	Cables	1-3
	Adaptors	1-4
	Cases.....	1-4
	Power Supply	1-4
	Software	1-4
	Selecting the Proper Transducer	1-5
	Triaxial Accelerometers	1-7
	Single Axis Accelerometers	1-9
	Modes of Operation	1-10
	Frequency Weighting Selections	1-10
	Band Limiting Filters	1-11
Chapter 2	Getting Started	2-1
	Switching HVM100 On	2-1
	Menu Navigation	2-1
	Alpha Numeric Menu Function	2-2
	Indexed Menu Function	2-3
	Key Board Functions	2-4
	Setup Key.....	2-4
	Mode Selection	2-5
	Averaging Time	2-5
	Time History Settings.....	2-6
	Store Time.....	2-7
	Auto Store	2-7
	2nd History.....	2-8
	Vibration Mode Weighting.....	2-8
	Hand Arm Mode Weighting	2-9
	Whole Body Weighting Mode.....	2-9

Chapter 3	Tools Menu	3-1
	Tools Key.....	3-1
	Accelerometer	3-1
	Display Units.....	3-2
	Integration	3-3
	Sum Factor X,Y, Z.....	3-4
	AC/DC Output	3-4
	AC/DC Output Settings.....	3-7
	Baud Rate	3-8
	Handshaking.....	3-8
	Print History Selection	3-8
	Erase All Files	3-9
	Erase Setups	3-10
	Header 1,2,3	3-11
	Language.....	3-12
	Date and Time.....	3-13
Chapter 4	Range Menu	4-1
	Range Key.....	4-1
	Auto Range	4-1
	Gain X, Y, Z.....	4-2
	Cal Level.....	4-2
	Calibrate X, Y, Z.....	4-3
	Sensitivity X, Y, Z	4-4
	Reference Acceleration	4-5
	Hand Arm Exposure Action Value	4-5
Chapter 5	Printing	5-1
	Printing to a Windows Hyperterminal	5-1
Chapter 6	Storing and Recalling Data Files and Setups	6-1
	STORE Key	6-1
	Storing a Setup	6-1
	Storing a File	6-3
	Temporary Data Storage - File Register 00	6-4
	Data Storage - File Registers 01 thru 99	6-5
	Preserving the File Counter At Power-Off	6-5
	Recall Key.....	6-6
	Recalling a Setup	6-6

	Recalling Setup Register S0 at Power-On	6-7
	Recalling a File	6-8
Chapter 7	Taking Measurements/ Viewing Data on the HVM100	7-1
	Run/Stop Key.....	7-1
	Overload Detection	7-1
	Under-Range Indicator (?)	7-2
	Run-Interrupted Indicator (!)	7-2
	History Key	7-3
	Viewing Time History with 2nd History turned on	7-5
	Data Key	7-6
Chapter 8	Powering the HVM100	8-1
	Checking the Remaining Battery Voltage	8-1
	Installing New Batteries.....	8-1
	Using External Power	8-4
Chapter 9	Connections on the HVM100	9-1
	Serial Interface Port	9-2
	Pinout	9-2
	Cables Used.....	9-3
	Transducer Connection	9-4
	Pinout	9-4
	External Power Connection	9-5
	Pinout	9-5
	Larson Davis Adapter	9-5
	AC/DC Output Connector.....	9-6
	Pinout	9-7
Chapter 10	Chapter 10 Adaptor Resonances	10-1
	Conclusion	10-1
	Mechanical.....	10-1
	Measurements	10-3
	Frequency Response Measurements.....	10-3
	ADP080A + SEN041	10-3
	ADP081A + SEN041	10-5
	ADP082A + SEN041	10-6

Appendix A Specifications

A-1

General Characteristics	A-1
Type Precision	A-1
Effects of Temperature	A-2
Effects of Humidity	A-2
Limits of Temperature and Humidity	A-2
Effects of Magnetic Fields	A-2
Effects of Mechanical Vibrations	A-2
Stabilization Time	A-2
Data Storage	A-3
Data Communications	A-3
Digital Display	A-3
Real-time Clock/Calendar	A-3
Run-time Clock	A-3
Power Supply	A-3
Dimensions/Weight	A-3
Declaration of Conformity	A-4
Outputs	A-5
Transducer Electrical Impedance	A-5
Direct Input	A-5
ICP [®] Input	A-5
Charge Input	A-6
Functions Measured	A-6
Reference Acceleration	A-6
Reference Calibration Frequency	A-7
Reference Calibration Vibration	A-7
Frequency Weighting Curves	A-8
Fa (Flat 0.4 Hz to 100 Hz)	A-8
Fb (Flat 0.4 Hz to 1260 Hz) Frequency Weighting	A-9
Fc (Flat 6.3 Hz to 1260 Hz), Wh, and Ws Frequency Weighting	A-12
Wm, Wc, and Wd Frequency Weightings	A-13
We, Wj, and Wk Frequency Weighting	A-15
Wg Frequency Weighting (Defined in BS6841:1987)	A-17
Wm (Whole Body) Frequency Weighting	A-18
Typical Measurements Ranges	A-20
Vibration - Fa	A-20
Vibration - Fb, Fc, Ws	A-21
Hand Arm - Wh	A-22

Whole Body - Wm	A-23
Whole Body - Wc.....	A-24
Whole Body - Wd, We.....	A-25
Whole Body - Wg	A-26
Whole Body - Wb, Wj, Wk.....	A-27

Appendix B Glossary B-1

Table of equations.....	B-1
RMS Acceleration	B-1
RMS Acceleration in Decibels.....	B-1
Allowed Exposure Time.....	B-2
Energy Equivalent RMS Acceleration	B-2
Running RMS Acceleration LINEAR.....	B-2
Running RMS Acceleration EXPONENTIAL	B-3
Vibration Dose Value.....	B-3
Maximum Transient Vibration Value	B-3
Minimum Transient Vibration Value.....	B-3
Long Term Maximum Peak	B-3
Short Term Maximum Peak	B-4
Long Term Crest Factor	B-4
Short Term Crest Factor.....	B-4
Summed Instantaneous Acceleration	B-4

Appendix C Serial Interface Commands C-1

Setup and Query Commands	C-1
Syntax for setup commands	C-1
Syntax for Query commands.....	C-2
System Parameters (Q's and S's).....	C-2
Mode Specific Parameters	C-3
Read Data Commands	C-9
Read Time History Commands.....	C-10
Control Commands	C-12

Appendix D Frequency Response Curves D-1

Appendix E Miscellaneous Information E-1

DC Output Calibration.....	E-1
AC/DC Outputs.....	E-3
DC Output	E-3
AC Output	E-4

Typical Measurement Ranges for Hand-Arm and Whole Body Measurements ...	E-5
ICP [®] Accelerometers	E-5
Typical Measurement Ranges for General Purpose Vibration Measurements	E-7
ICP Accelerometers	E-7

Appendix F Serial Number Backup F-1

Setting Serial Number Backup.....	F-1
Serial Number Reset	F-1
Failure of Serial Number Reset.....	F-2

Introduction

Thank you for purchasing the Human Vibration Meter from Larson Davis. The HVM100 is a powerful but small vibration measurement tool. This Handheld vibration analyzer will allow a variety of applications to be performed including; Whole Body Vibration analysis, Hand-Arm Vibration analysis, and general purpose vibration analysis.

This full featured vibration analyzer features 3 input channels, a sum channel, a variety of frequency weighting and band limiting settings, single and double integration, displayed data in a variety of units, and independent AC or DC outputs for all 3 channels simultaneously.

We invite you to read this manual to obtain the best results from your HVM100.

About This Manual

This manual has 9 chapters and 5 appendices covering the following topics:

Chapter 1 - Introduction

In this chapter we will discuss the functionality and capabilities of your HVM100. We will also go into detail with regards to frequency weightings and screen and menu functionality.

Chapter 2 - Getting Started

This chapter will describe in detail the functionality and selections contained in the Setup menu.

Chapter 3 - The Tools Menu

This chapter will describe in detail the functionality and selections contained in the Tools menu.

Chapter 4 - The Range Menu

This chapter will describe in detail the functionality and selections contained in the Range menu. This includes calibration of the HVM100.

Chapter 5 - Printing

This chapter will describe how to download data from the HVM100.

Chapter 6 - Storing and Recalling Data Files and Setups

This chapter will describe in detail how to store data and setup information in the HVM100's on-board memory.

Chapter 7 - Taking Measurements/Viewing Data on the HVM100

This chapter will describe in detail how to use the Run/Stop key to take measurements, and how to view that data on the display of the HVM100.

Chapter 8 - Powering the HVM100

This chapter will describe the two ways in which to power the HVM100.

Chapter 9 - Connections on the HVM100

This chapter will describe all of the external connectors on the HVM100.

Chapter 10- Adaptor Resonances

This chapter will describe the frequency response function data for the ADP08XA Adaptors.

Appendix A - Specifications

Appendix B - Glossary

Appendix C - I/O Commands

Appendix D - Frequency Response Curves

Appendix E - Miscellaneous Information

Appendix F - Serial Number Backup

Accessories

Selection of the proper accessories for use with your HVM100 is one of the most important functions you can perform. The transducer is especially critical to obtaining good results.

Standard Accessories

The HVM100 is delivered with the following *standard* accessories:

- User Manual
- Batteries, 2 x AA, IEC Type LR6

Optional Accessories

Transducers

- SEN020 to SEN022 (Accelerometers, 3 axis ICP®)
- SEN023 to SEN025 (Accelerometers, single axis ICP)
- SEN026 (3 axis ICP, palm accelerometer)
- SEN027 (Accelerometer, seat pad)
- SEN040F (Accelerometer, 3 axis, 2 - 5 kHz, ICP)
- SEN041F (Accelerometer, 3 axis, 2 - 5 kHz, ICP)

Calibrator

- 394C06 (Hand-held accelerometer calibrator)

Cables

- SEN020-CBL to SEN022-CBL (3 axis accelerometers including cables)
- SEN023-CBL to SEN025-CBL (single axis accelerometers including cables)
- SEN026-CBL (3 axis ICP, palm accelerometer including cable)
- SEN027-CBL (Cable and seat pad accelerometer)
- SEN040F-CBL (Accelerometers, 3 axis, 2 - 5 kHz, ICP, including cables)
- SEN041F-CBL (Accelerometers, 3 axis, 2 - 5 kHz, ICP, including cables)
- CBL006 (Cable, serial computer, DB9S-mDIN08)

- CBL120 (Cable, 3 x 10-32 male to 4-pin LEMO[®] female)
- CBL121 (cable, 3 x BNC male to 4-pin LEMO female)
- CBL124 (Cable, AC/DC Output, 3 X BNC to Switchcraft[®])
- CBL125 (Cable, Mini 4-pin to 4-pin LEMO female)
- CBL158 (Cable, 4-pin Microtech to 4-pin LEMO male)

Adaptors

- ADP060 (Adapter, hand accelerometer)
- ADP061 (Adapter, handle accelerometer)
- ADP062 (Adapter, clamp accelerometer)
- ADP063 (Adaptor, palm accelerometer)
- ADP064 (HVM100 adapter kit)
- ADP080A (Adapter, hand accelerometer)
- ADP081A (Adapter, handle accelerometer)
- ADP082A (Adapter, clamp accelerometer)
- ADP084A (Vibration adaptor kit including ADP080A, ADP081A, ADP082A and ADP063)
- 080A09 (Adaptor, probe tip with 10-32 connector)
- 080A17 (Adaptor, triaxial mounting)
- 080B16 (Adaptor, triaxial mounting, for SEN024 and SEN025 with 5-40 thread)

Cases

- CCS020 (HVM100 hard shell carrying case)
- CCS028 (Soft case with belt clip for HVM100)

Power Supply

- PSA027 (Power supply, 90-264 VAC to 12 VDC)

Software

- Blaze[®] software (SWW-BLAZE-HVM) for setup, control and high speed data download
- HVManager software permits both users and manufacturers of vibrating equipment to create PC-based vibration data bases containing data measured using an HVM100 Human Vibration Meter
- DNA (Data, Navigation and Analysis) software for instrument control, high speed data download, data streaming with real-time data display on PC, advanced data graphic presentations and powerful report generation features

- HVM Programmer software, available from Larson Davis, can be used to program the languages and update the firmware when new versions are available for the HVM100.

Selecting the Proper Transducer

There are several important considerations when selecting a transducer to perform your measurements. The first decision that must be made is what type of transducer to use.

There are two general categories of accelerometers, ICP[®] and Charge.

- ICP[®] accelerometers are also called “Voltage Mode” or “Low impedance” and may be known by various other vendor trade names. ICP is PCB’s registered trademark which stands for “Integrated Circuit Piezoelectric” and identifies PCB sensors which incorporate built-in, signal conditioning electronics. The built-in electronics serve to convert the high impedance charge signal that is generated by the piezoelectric sensing element to a usable low impedance voltage signal which can be readily transmitted over ordinary 2 wire or coaxial cables to any voltage readout or recording device. The low impedance signal can be transmitted over long cable distances and used in dirty field or factory environments with little signal degradation.
- Charge mode sensors output a high impedance, electrical charge signal that is generated by the piezoelectric sensing element. This signal is extremely sensitive to corruption from environmental influences. To conduct accurate measurements, it is necessary to condition this signal to a low impedance voltage before it can be input to a readout or recording device. A charge amplifier or in-line charge converter is generally used for this purpose.

NOTE: The HVM100 has built-in ICP[®] power supplies and charge amplifiers. This will allow the HVM100 to interface directly with ICP or charge transducers, and eliminates the need for external signal conditioning.

The final way to use the input of the HVM100 is through the direct input. This would require the use of some kind of external signal conditioning unit such as an external source of ICP power, or an external charge amplifier.

The next item to consider is the sensitivity of the transducer. The sensitivity of the accelerometer will depend on the application being performed. If the application is a high vibration level application, a low sensitivity should be selected. For low vibration level applications a high sensitivity accelerometer should be used.

NOTE: Transverse sensitivity is also something to be considered. Transverse sensitivity is defined as: The unwanted output signal of a motion sensor when subjected to motion perpendicular to the sensitive axis-usually expressed as a percent of the normal axis sensitivity. For example if you are using a tri-axial accelerometer and place an input signal on the Z axis, your X axis could also be reading a level even though there is really no x-axis signal present.

The resonant frequency of the transducer should also be considered. The resonant frequency is defined as the frequency at which the structure will readily vibrate. For accelerometers, there is one frequency where the accelerometer will vibrate much easier than at other frequencies. At this point, the reading will be very high, and could overload the input of the HVM100. However, for most of the recommended accelerometers, the resonant frequency is well above the upper limit of the HVM100, and will subsequently be masked out by the low pass filter on the HVM100. If the resonant frequency becomes an issue, it is recommended that an external mechanical filter be used.

Frequency range is the next thing to take into consideration. Most recommended accelerometers will have a frequency range sufficient for use with the HVM100. See the frequency response tables (appendix A) and graphs (appendix D) for more information on the HVM100's frequency response.

The last thing to consider is temperature, humidity, and other physical agents, such as mounting surface, mass and environment. The mass of the accelerometer should ideally be no more that 1/50 of the mass of the object being measured. A ratio of as little as 1/10 is acceptable in extreme circumstances. The affect of these elements should always be considered when choosing a transducer. Please also be aware of the different methods of mounting an accelerometer and the effects of each of those methods on the measured data.

The following is a selection from the PCB catalog listing the characteristics of a transducer. Please note the items that we have discussed and note where they appear in a transducer specification

Triaxial Accelerometers

Specification	Unit	SEN020	SEN21F	SEN026
Voltage Sensitivity	mV/g	1	10	10
Frequency Range (+/-5%)	Hz	0.5 to 5,000	0.5 to 2,500	1 to 9,000
Frequency Range (+/-10%)	Hz	0.3 to 6,000		0.5 to 12,000
Mounted Resonant Frequency	kHz	≥25	≥25	≥25
Measurement Range	+/-g pk	1,500	500	500
Broadband Resolution (1 Hz to 10 kHz)	g rms	0.005	0.0005	0.0002
Shock Limit	+/-g pk	7,000	7,000	10,000
Operating Temperature Range	°F [°C]	-65 to +250 [-54 to +121]	-65 to +250 [-54 to +121]	-65 to +250 [-54 to +121]
Amplitude Linearity	%	≤+1	≤+1	≤+1
Transverse Sensitivity	%	≤5	≤5	≤5
Strain Sensitivity	g/με	0.001	0.001	
Excitation Voltage	VDC	20 to 30	20 to 30	18 to 30
Constant Current	mA	2 to 20	2 to 20	2 to 20
Output Impedance	ohms	<100	<100	<200
Output Bias	VDC	8 to 12	8 to 12	7 to 11
Discharge Time Constant	sec	1.0 to 2.0	.4 to 1.2	1.0 to 3.5
Sensing Element	Type	Ceramic	Ceramic	Ceramic
Element Configuration	Structure	Shear	Shear	Shear
Electrical Connector	type/location	4-Pin/side	4-Pin/side	4-Pin/side
Housing	material/sealing	Titanium/Hermetic	Titanium/Hermetic	Titanium/Hermetic
Mounting Thread	size	10-32 Female	5-40 Male	10-32 Female

Specification	Unit	SEN027	SEN040F	SEN041F
Voltage Sensitivity	mV/g	100	1	10
Frequency Range (+/-5%)	Hz	0.5 to 1,000	2 to 4,000	2 to 4,000
Frequency Range (+/-10%)	Hz			
Mounted Resonant Frequency	kHz	≥27	≥55	≥55
Measurement Range	+/-g pk	10	5,000	500
Broadband Resolution (1 Hz to 10 kHz)	g rms	0.002	0.03	0.008
Shock Limit	+/-g pk	2,000	10,000	10,000
Operating Temperature Range	°F [°C]	+14 to +122 [-10 to +50]	-65 to +250 [-54 to +121]	-65 to +250 [-54 to +121]
Amplitude Linearity	%	≤+1	≤+2.5	≤+1
Transverse Sensitivity	%	≤5	≤5	≤5
Strain Sensitivity	g/με			
Excitation Voltage	VDC	6.5 to 30	18 to 30	18 to 30
Constant Current	mA	0.3 to 10	2 to 20	2 to 20
Output Impedance	ohms	<500	<200	<200
Output Bias	VDC	2.8 to 4.5	7 to 11	7 to 11
Discharge Time Constant	sec	1.0 to 3.0	1.5 to 3.0	.3 to 1.0
Sensing Element	Type	Ceramic	Ceramic	Ceramic
Element Configuration	Structure	Shear	Shear	Shear
Electrical Connector	type/location	Integral cable/side	1/4-28 4-Pin/side	1/4-28 4-Pin/side
Housing	material/sealing	Titanium/Hermetic	Titanium/Hermetic	Titanium/Hermetic
Mounting Thread	size	10-32 Female	5-40 Female	5-40 Female

Single Axis Accelerometers

Specification	Unit	SEN022	SEN024	SEN025
Voltage Sensitivity	mV/g	100	10	10
Frequency Range (+/-5%)	Hz	0.5 to 5,000	1 to 12,000	1 to 10,000
Frequency Range (+/-10%)	Hz	0.3 to 6,000	0.7 to 18,000	0.3 to 12,000
Mounted Resonant Frequency	kHz	≥25	≥50	≥35
Measurement Range	+/-g pk	50	500	50
Broadband Resolution (1 Hz to 10 kHz)	g rms	0.0001	0.0005	.00016
Shock Limit	+/-g pk	7,000	10,000	5000
Operating Temperature Range	°F [°C]	-65 to +176 [-54 to +80]	-65 to +250 [-54 to +121]	-65 to +200 [-54 to +93]
Amplitude Linearity	%	≤+1	≤+1	≤+1
Transverse Sensitivity	%	≤5	≤5	≤5
Strain Sensitivity	g/με	0.001	0.006	0.005
Excitation Voltage	VDC	20 to 30	1 to 30	1 to 30
Constant Current	mA	2 to 20	2 to 20	2 to 20
Output Impedance	ohms	<200	<100	<300
Output Bias	VDC	8 to 12	8 to 12	8 to 12
Discharge Time Constant	sec	1 to 3	.4 to 1.2	.4 to 1.2
Sensing Element	Type	Ceramic	Ceramic	Ceramic
Element Configuration	Structure	Shear	Shear	Shear
Electrical Connector	type/location	4-Pin/side	10-32	10-32
Housing	material/sealing	Aluminum/Epoxy	Titanium/Hermetic	Titanium/Hermetic
Mounting Thread	size	10-32 Male	5-40 Male	5-40 Male

About the HVM100

The HVM100 is a powerful, all digital, vibration analyzer. It features simultaneous 3 channel measurements, small lightweight design, easy to read display, portability utilizing 2 AA batteries, 115.2 kbps RS-232 interface, three modes of

operation: Hand-Arm, Whole Body, and Vibration, and the capability to display and print text in a variety of languages.

Modes of Operation

The HVM100 is divided into three modes of operation. The standard mode is the vibration mode. This is the mode included with the instrument. The other two modes are optional modes. The Optional modes are Hand-Arm and Whole Body. Each of these modes feature different frequency weighting selections as outlined later in this chapter.

Frequency Weighting Selections

NOTE: The Hand-Arm and Whole body modes are separately purchased options. These options and the frequency weightings associated with these options will not be available unless they are purchased.

To accommodate the multiple operating modes of the HVM100, 13 different frequency weighting filters are available. The following table describes the frequency weighting options available in each of the operating modes. To select the frequency weighting for a particular mode, see the section in this manual titled Setup Key.

Mode	Frequency Weighting
Vibration	Ws (Severity) Fa (0.4 Hz to 100 Hz) Fb (0.4 Hz to 1250 Hz) Fc (6.3 Hz to 1250 Hz)
Hand Arm	W_h
Whole Body	W_m W_b W_c W_d W_e W_g W_j W_k

The Hand-Arm mode and the Whole body mode frequency weighting curves are defined in ISO 8041:2005. The W_g

frequency weighting curve is defined in British Standard 6841:1987.

Band Limiting Filters

In addition to defining the frequency weightings for Hand-Arm and Whole Body, ISO 8041:2005 also defines a band-limiting filter to be used with each of the frequency weightings. Each band-limiting filter is a combination of a high-pass and low-pass 2nd order Butterworth filter, 12 dB per octave attenuation, with - 3 dB corner frequencies at the frequencies listed in table 3 below. When a frequency weighting is selected in the HVM100 Hand-Arm mode, or Whole Body mode, the HVM100 automatically places both the weighting filter and the appropriate band-limiting filter in the signal path.

Weighting	Band-Limiting Filter
W_h	6.3 to 1250 Hz
$W_m, W_c, W_d, W_e, W_j, W_k$	0.4 to 100 Hz
W_m, W_g	0.8 to 100 Hz

Getting Started

This section will introduce you to the keypad and functionality of the HVM100.

Switching HVM100 On

If any displays appear during the boot process which refer to Serial Number or SN, see section "Serial Number Backup" on page F-1.

To switch the HVM100 On, press the On key.

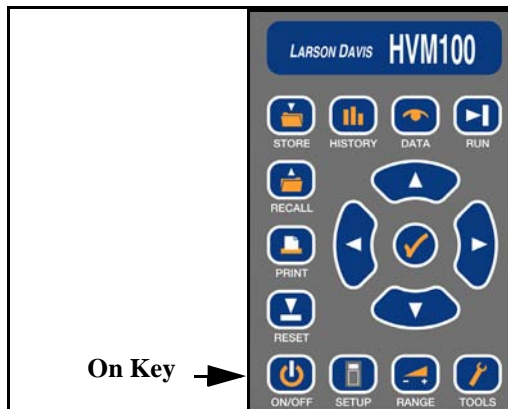

Menu Navigation

Navigating through the HVM100 menus is similar to navigating through other Larson Davis instruments. The menus are arranged in lists. The appropriate menu key is used to enter the menu, and then the ▲ Up and ▼ Down arrow keys are used to scroll through the menu. When you come to a setting you want to change, press the ✓ Check key to enter the modify section of the menu. You can now use the ► Right and ◀ Left arrow keys to scroll through the options for that item. After the appropriate selection is in the window, use the ✓ Check key to select that setting. This will place you back into the main menu where once again the ▲ Up and ▼ Down arrow keys can be used to navigate.

Alpha Numeric Menu Function

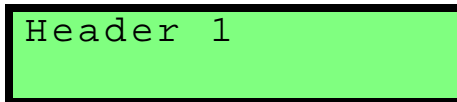

The alpha numeric menu screens include the Header screens and the Calibrator sensitivity screen. These are settings that require the user to enter letters of the alphabet or numerals into the field. To change an alpha numeric menu setting,

Step 1 Go to the menu item you wish to change.

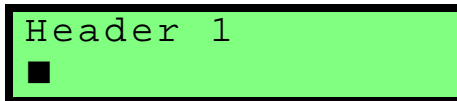

A screenshot of a menu screen with a black border. The text 'Header 1' is displayed in a monospaced font on a light green background.

Step 2 Press the  key to place the HVM100 into the modify mode. The selection will begin to blink.

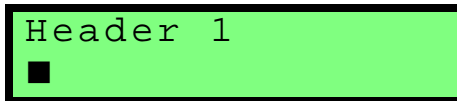

A screenshot of the 'Header 1' menu screen. A small black square cursor is positioned at the beginning of the second line, below the first line.

Step 3 Use the  and  arrow keys to select a position to modify.

A screenshot of the 'Header 1' menu screen. The cursor is now positioned under the first character 'H' of the second line.

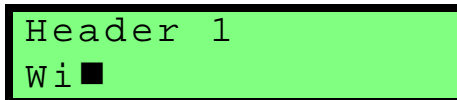
Step 4 Use the  and  arrow keys to select the character you want in that position.

A screenshot of the 'Header 1' menu screen. The second line now shows 'Wi' followed by the cursor.

Step 5 Use the  and  arrow keys again to move to the next position. When you move to the next position, the HVM100 will start you from where you left off. (i.e. if you entered an 'F' in the first position, when you move to the next position, you will be starting from the 'F' on that position.)

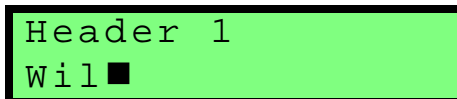
A screenshot of the 'Header 1' menu screen. The second line now shows 'Wil' followed by the cursor.

Step 6 Hit the  key or move to the next menu item to accept the change. Anytime you have made a change, the change will automatically be accepted

even if you don't hit the check key. You can accept the change just by moving to another section of the HVM100.

```
Header 1
Wilson Processin
```

Indexed Menu Function

The following is an example of how to make a change to an indexed menu item. (An item that has a specific list of choices.)

Step 1 Go to the setting you wish to change.

```
Operating Mode
Vibration
```

Step 2 Press the $\text{\textcircled{V}}$ key to place the HVM100 in the modify mode. The selection will begin to blink.

```
Operating Mode
Vibration
```

Step 3 Use the $\text{\textcircled{L}}$ and $\text{\textcircled{R}}$ arrow keys to scroll through the selections in the menu.

```
Operating Mode
Vibration
```

r

```
Operating Mode
Hand Arm
```

r

```
Operating Mode
whole Body
```

Step 4 When you come to the selection you desire, stop scrolling.

```
Operating Mode
Whole Body
```

Step 5 To accept the change, either hit the  key or move to the next menu item or to another part of the HVM100.

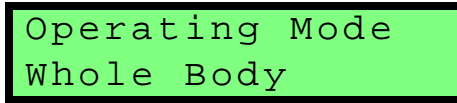

Key Board Functions

The keyboard on the front of the HVM100 is the main interface to the instrument. The keyboard consists of 11 dedicated function keys, 4 arrow keys and the check key.





In the following section, we will describe the functionality and selections associated with each key.

Setup Key

The **SETUP** key places you into the Setup menu. This menu is used to set general system parameters such as operating mode and frequency weighting. The selections available in the Setup menu are described below. The Setup menu is a

circular menu. You can scroll through and return to the top by continuously pressing the d or u arrow key.

Mode Selection

Hint: *This setting is in the Setup menu. To access the Setup menu press the **SETUP** key and then use the  and  arrow keys to navigate through the menu items.*



NOTE: To view each selection, first press the  key, and then press the r or l arrow key to scroll through each selection.

NOTE: The Hand-Arm and Whole body modes are separate purchased options. These options and the frequency weightings associated with those options will not be available unless they are purchased.

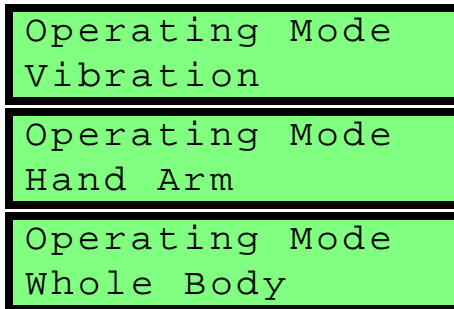
This section is used to set the operating mode. The selections are Whole body, Hand Arm or Vibration.



Averaging Time

Hint: *This setting is in the Setup menu. To access the Setup menu press the **SETUP** key and then use the  and  arrow keys to navigate through the menu items.*

NOTE: An exponential detector is defined as a detector that maintains a moving average of the signal. The only exponential detector in the HVM100 is the Slow detector. This detector will begin by taking a 1 second average. As time moves, the exponential detector will discard the first part of the average, as the next part is collected. A linear detector will take the signal and average over the averaging time, and then start over. All previously collected samples are disregarded in the new linear average.

Time History Settings

NOTE: To view each selection, first press the \odot key, and then press the r or l arrow key to scroll through each selection.

The averaging time refers to the amount of time data is collected and averaged before a new average is started. The selections are Slow, 1 sec, 2 sec, 5 sec, 10 sec, 20 sec, 30 sec, and 60 sec. The Slow response is a 1 second exponential detector, while the others are linear repeat type averages. The averaging is the same for all Operating modes.

The Averaging time is also used to determine the rate of storage for the Time History. The Time History will store the Arms value along with the Peak value if the user desires, for the X, Y, Z, and Sum channels. The Time History buffer is limited to 240 samples, 120 samples if the Peak value is selected. To setup Time History Peak storage, see the 2nd History menu section below.

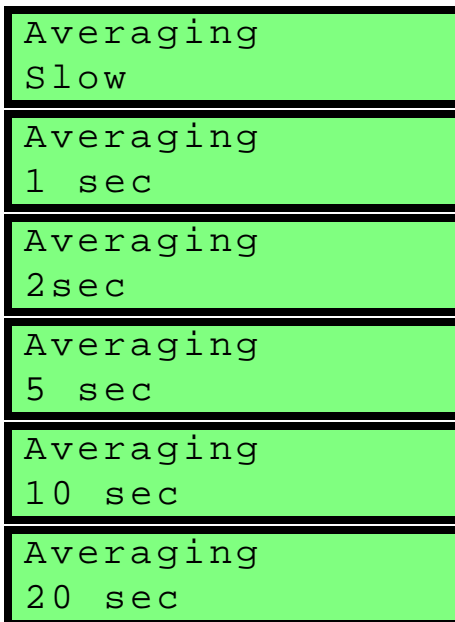

The following are the selections you would encounter when changing the Averaging Time:









```
Averaging
30 sec
```

```
Averaging
60 sec
```

Store Time



Hint: This setting is in the Setup menu. To access the Setup menu press the **SETUP** key and then use the  and  arrow keys to navigate through the menu items.

NOTE: To change the Store Time parameters, press the  key, use the  and  arrows to select the desired value, and then use the  and  arrows to move to the next position. Once all positions are set press the  key or move to any other part of the HVM100 to accept the entry.

The Store Time selection works in conjunction with the Auto Store setting. The Auto Store setting will allow you to automatically store measurement data at a rate indicated by the Store Time. The Store Time can be set from 1 minute to 99 hours.

```
Store Time hh:mm
00:00
```

Auto Store

Hint: This setting is in the Setup menu. To access the Setup menu press the **SETUP** key and then use the  and  arrow keys to navigate through the menu items.

NOTE: The data memory in the HVM100 is a non-volatile EEPROM chip. Even if the batteries go dead for an extended period of time, the stored setups and data will be retained.

The Auto Store function in the HVM100 will allow you to store data over time. The Store Time is the rate at which the data will be stored. At the end of the store time the Auto Store function will store any history data that has been collected, as well as the overall data from all three channels and the sum channel. The data will be stored as a file in the memory. After the data is stored, the instrument is reset automatically and a new set of data is collected. The limitation on the memory is 100 files. When the memory reaches the maximum number of files, it will stop storing data.

NOTE: To view each selection, first press the  key, and then press the r or l arrow key to scroll through each selection.

There are three selections in the Auto Store menu:

```
Auto Store
off
```

The Auto Store is turned off with this setting.

```
Auto Store
On
```

The Auto Store feature will store each time the Store Time is reached. This will continue until all file registers are full.

```
Auto Store
Autostop
```

The Auto Store-Autostop feature will allow you to take a fixed length measurement. The Autostop feature will stop the meter when the Store time is reached, just as if you had pressed the s key.

2nd History

Hint: *This setting is in the Setup menu. To access the Setup menu press the **SETUP** key and then use the ▲ and ▼ arrow keys to navigate through the menu items.*

The 2nd History setting will allow you to store a Peak value along with the Arms value that is automatically stored in the Time History buffer. The Peak will be stored for all three channels and the Sum channel. Turning on the 2nd value will cut the number of sample storage space from 240 samples to 120 samples.

NOTE: To view each selection, first press the ⌚ key, and then press the r or l arrow key to scroll through each selection.

In the 2nd history selection menu you have the choice of None or Peak.

```
2nd history
None
```

```
2nd History
Peak
```

Vibration Mode Weighting

Hint: *This setting is in the Setup menu. To access the Setup menu press the **SETUP** key and then use the ▲ and ▼ arrow keys to navigate through the menu items.*

NOTE: To view each selection, first press the \odot key, and then press the r or l arrow key to scroll through each selection.

In the vibration mode you can select from the following weighting selections. Please see the appendix at the end of this manual for details on weighting curves. The weighting selection is independent for all channels. Here we only depict the X channel data, but the other channels screens would be the same:

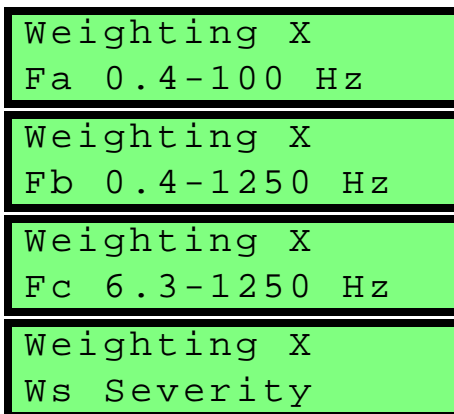

Hand Arm Mode Weighting

As required by ISO 8041:2005 the Hand Arm mode has only one weighting selection. Please see the appendix at the end of this manual for details on this weighting curve. The weighting curve is labeled as Wh. This weighting selection is for all channels and the sum channel. Because there is only one selection in the Hand Arm mode, the weighting selection is not present on the Setup menu.

Whole Body Weighting Mode

Hint: *This setting is in the Setup menu. To access the Setup menu press the **SETUP** key and then use the \blacktriangle and \blacktriangledown arrow keys to navigate through the menu items.*

NOTE: To view each selection, first press the \odot key, and then press the r or l arrow key to scroll through each selection.

In the Whole Body mode you can select from the following weighting selections as required by ISO8041:2005. Please see the appendix at the end of this manual for details on the weighting curves. The weighting selection is independent

for all channels. Here we only depict the X channel data, but the other channels screens would be the same:

Weighting X
Wm

Weighting X
Wb

Weighting X
Wc

Weighting X
Wd

Weighting X
We

Weighting X
Wg

Weighting X
Wj

Weighting X
Wk

NOTE: The Wg frequency weighting curve is defined in BS 6841:1987.



Tools Menu

The Tools menu has settings relating to the transducer and setup information relevant to the instrument. Selections include communications, printing, headers, etc.

Tools Key

The tools menu functions in exactly the same manner as the Setup menu and has the following selections:

Accelerometer

Hint: This setting is in the Tools menu. To access the Tools menu press the **TOOLS** key and then use the  and  arrow keys to navigate through the menu items.

NOTE: To view each selection, first press the  key, and then press the r or l arrow key to scroll through each selection.

This will allow you to select the type of transducer you wish to use. The selections are ICP[®], Direct, and Charge. These refer to the type of accelerometer being used.

```
Accelerometer
Direct
```

The Direct setting is used to input a direct signal from a transducer. No operational power is provided to the transducer.

```
Accelerometer
ICP          XDC=10.0V
```

The ICP[®] setting will provide a 28 Volt 2mA constant current to each of the three input channels, in order to power up to three accelerometers. This is used with ICP type accelerometers. The voltage reported on this screen is a monitoring of the ICP power being provided to the

transducer. When the transducer is not connected, this voltage will read 25 to 26 volts. If you have a transducer connected and it is working properly, it should be reading between 2 and 12 volts depending upon the transducer.

The following table shows the typical bias voltage for the various ICP[®] accelerometers that are normally used with the HVM100.



<u>Tri-Axial Accelerometers</u> SEN020 SEN022	<u>Single Axis Accelerometers</u> SEN023 SEN024 SEN025	<u>Palm-Adapter Accelerometer</u> SEN026	<u>Seat Pad Accelerometer</u> SEN027
8-12 volts	8-12 volts	7-11 volts	2-5 volts

If the reading is 0, then the ICP[®] power could be shorted to ground or have some other problem. Check all connections, cables, and connectors.

Accelerometer
Charge

This setting would be used to amplify the signal from a charge type accelerometer.

Display Units

Hint: This setting is in the Tools menu. To access the Tools menu press the **TOOLS** key and then use the  and  arrow keys to navigate through the menu items.

NOTE: To view each selection, first press the  key, and then press the r or l arrow key to scroll through each selection.

The Display Units setting controls how data is displayed and printed by the HVM100. The HVM100 can display data in six different formats. The selection of the display units will apply to all three channels and the sum channel. All channels will have the same units. The choices are: m/s², cm/s², ft/s², in/s², g, and dB.

NOTE: The HVM100 uses a reference acceleration of 10^6 m/s² (velocity reference = 10^9 m/s, displacement reference = 10^{12} m) or a reference of 10^5 m/s² (velocity reference = 10^8 m/s, displacement reference = 10^{11} m) to display acceleration, velocity and displacement in dB units. Please see the section in the RANGE key for details on changing the reference acceleration.

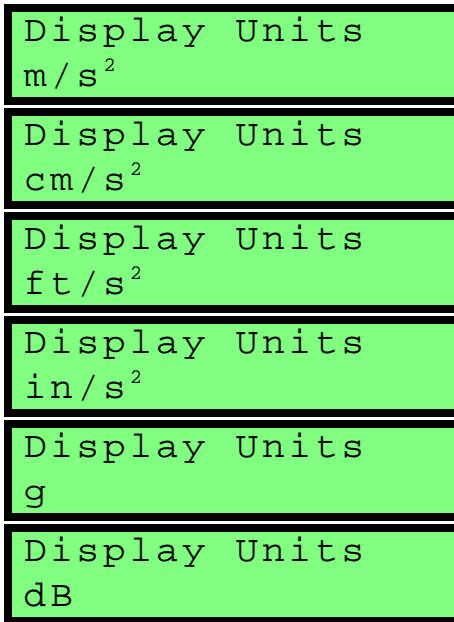

Integration

Hint: This setting is in the Tools menu. To access the Tools menu press the **TOOLS** key and then use the \blacktriangle and \blacktriangledown arrow keys to navigate through the menu items.

NOTE: Integration is a mathematical process of changing the displayed units from acceleration to velocity to displacement. Single integration changes the displayed parameter from acceleration to velocity by dividing the acceleration by: $2\pi f$ (i.e. ft/s^2 to ft/s). Double integration changes the parameter from acceleration to displacement by dividing the acceleration by: $4\pi^2 f^2$ (i.e. m/s^2 to meters).

Integration applies only to the Vibration mode. There is no integration available in the Hand Arm or Whole Body Modes. Integration is the process of converting the data from acceleration, which is the standard method of displaying the data, into velocity and displacement.

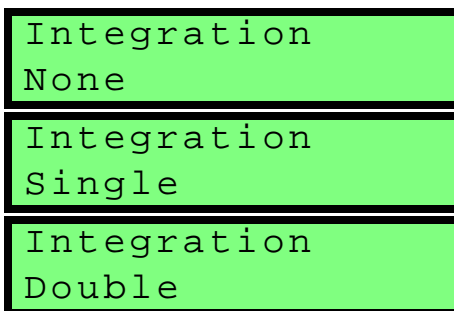

NOTE: To view each selection, first press the \downarrow key, and then press the r or l arrow key to scroll through each selection.

Single integration will express the units in velocity, and double integration will express the units in displacement.

Sum Factor X,Y, Z

Hint: *This setting is in the Tools menu. To access the Tools menu press the **TOOLS** key and then use the \blacktriangle and \blacktriangledown arrow keys to navigate through the menu items.*

In the process of calculating the sum quantities (the data that appears under the Σ menu) the HVM100 multiplies the instantaneous acceleration for each channel by a scaler factor (sometimes called a k-factor). The HVM100 allows the user to select a different k factor for each channel. The default setting is 1.00; however; some applications may require different settings.

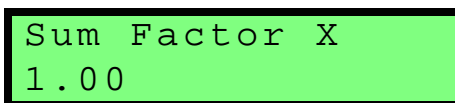

The image shows a green rectangular display area with a black border. Inside, the text 'Sum Factor X' is displayed on the top line, and '1.00' is displayed on the bottom line.

NOTE: To change the Sum Factor parameter, press the \downarrow key, use the \blacktriangle and \blacktriangledown arrows to select the desired value, and then use the \blacktriangleright and \blacktriangleleft arrows to move to the next position. Once all positions are set press the \downarrow key or move to any other part of the HVM100 to accept the entry.

The applications that require the Sum Factor to be altered are specified in certain ISO standards. If you are not trying to measure according to any specific standard, the appropriate setting for this parameter is 1.00.

Quantities affected by sum factors are A_{rms} , A_{min} , A_{max} , A_{mp} , A_{eq} , Peak, PE and VDV. Individual axis data is not affected.

AC/DC Output

Hint: *This setting is in the Tools menu. To access the Tools menu press the **TOOLS** key and then use the \blacktriangle and \blacktriangledown arrow keys to navigate through the menu items.*

The AC/DC outputs on the HVM100 are independent and simultaneous for all three channels. First we will discuss the output in general, and then give the specific settings for the AC/DC outputs.

NOTE: To view each selection, first press the V key, and then press the \uparrow or \downarrow arrow key to scroll through each selection.

AC output is useful for frequency analysis by an external analyzer or for recording in a tape recorder. The DC output is useful for a chart recorder, or to measure the voltage proportional to the RMS or peak value.

The DC output is updated according to the averaging time. If the averaging time is set to slow, the signal on the DC output pin for the selected channel will be updated once per second. If the averaging time is set to 60 seconds, the signal on the DC output pin for the selected channel will be updated once every 60 seconds.

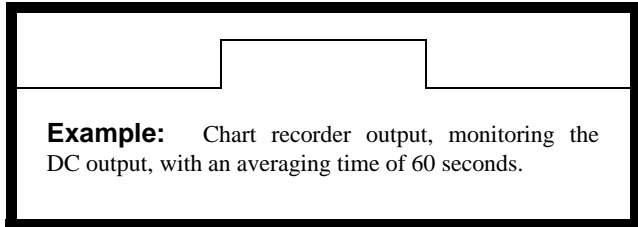

The AC/DC output connector is a 5 pin Switchcraft® connector located on the bottom edge of the instrument. The pinout is as follows:



Pin #	Description
1	Ground
2	X - Axis AC/DC Output
3	Y - Axis AC/DC Output
4	No Connection
5	Z - Axis AC/DC Output

The signal that is output on each pin is selectable for each channel. The selections are the same for each channel. We will list the X channel selections, however the available selections will be the same for all operating modes as well.

The AC output will produce a signal from 0 - 0.5 Volt RMS.

The scale of the DC output is typically 5 mV/dB. The level typically varies between 0 Vdc to +1.0 Vdc.

AC/DC Output Settings

The weighting filters work in conjunction with the band limiting filters. See page 1-7.

Setting	Description
AC/DC Output X AC: Weighted	AC: Weighted This will weight the output pin for the selected channel according to the weighting selected for that channel. If Channel X has a weighting of W_s , then the output pin for Channel X will produce a W_s weighted AC signal.
AC/DC Output X AC: BandLimit	AC: Band-Limit This will weight the output pin for the selected channel according to the Band Limiting filter, specified in chapter 1, for that channel. For example if Channel X has a weighting of W_b , then the output pin for Channel X will produce a band limited (6.3 to 1250 Hz) AC signal.
AC/DC Output X DC: rms	DC: rms This signal will be a DC voltage with a level proportional to the RMS level displayed on the HVM100.
AC/DC Output X DC: min	DC: min This signal will be a DC voltage with a level proportional to the min level displayed on the HVM100.
AC/DC Output X DC: max	DC: max This signal will be a DC voltage with a level proportional to the max level displayed on the HVM100.
AC/DC Output X DC: peak	DC: peak This signal will be a DC voltage with a level proportional to the peak level displayed on the HVM100.
AC/DC Output X DC: rms Σ	DC: rms Σ This signal will be a DC voltage with a level proportional to the RMS sum level displayed on the HVM100.
AC/DC Output X DC: min Σ	DC: min Σ This signal will be a DC voltage with a level proportional to the min sum level displayed on the HVM100.
AC/DC Output X DC: max Σ	DC: max Σ This signal will be a DC voltage with a level proportional to the max sum level displayed on the HVM100.
AC/DC Output X DC: peak Σ	DC: peak Σ This signal will be a DC voltage with a level proportional to the peak sum level displayed on the HVM100.

Only one selection can be made for each channel. Channels Y and Z will have the same selection of settings. The weighting selected can be independent for each channel.

Baud Rate

Hint: This setting is in the Tools menu. To access the Tools menu press the **TOOLS** key and then use the ▲ and ▼ arrow keys to navigate through the menu items.

The Baud rate selection will allow you to communicate with the PC or the serial printer. The choices are as follows:

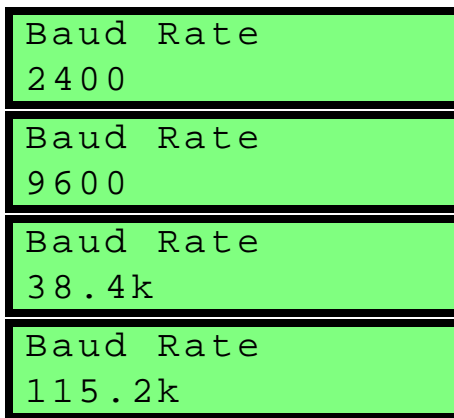

NOTE: To view each selection, first press the ⌵ key, and then press the r or l arrow key to scroll through each selection.

It is important that the setting on your computer or on the serial printer match the Baud Rate setting of the HVM100.

Handshaking

The handshaking on the HVM100 is defaulted to hardware (DTR) handshaking.

Print History Selection

Hint: This setting is in the Tools menu. To access the Tools menu press the **TOOLS** key and then use the ▲ and ▼ arrow keys to navigate through the menu items.

The print history selection will determine whether or not the HVM100 will send the History Buffer information when the **PRINT** key is pressed.

```
Print History
Yes
```

NOTE: To view each selection, first press the **⏴** key, and then press the **r** or **l** arrow key to scroll through each selection.

This selection will cause the HVM100 to send data contained in the History buffer to the printer.

```
Print History
No
```

With this selection, the HVM will only send the overall data from the 3 input channels and the sum channel.

Erase All Files

Hint: This setting is in the Tools menu. To access the Tools menu press the **TOOLS** key and then use the **⏴** and **⏵** arrow keys to navigate through the menu items.

This allows you to clear the measurement files from the memory of the HVM100. The memory in the HVM100 is a non-volatile memory. If the batteries go dead, the measurement files will not be lost. The only way to clear out the file registers is to use the Erase All files menu.

This command will not clear the current measurement, or the current history buffer information. The **R** Reset key is used for that purpose. This command will only clear the file registers.

To clear all files:

NOTE: To view each selection, first press the **⏴** key, and then press the **r** or **l** arrow key to scroll through each selection.

Step 1 Go to the Erase All Files menu item.

Step 2 The following screen will appear. Press the **⏴** key. The 'No' will start to flash. Press the **r** key to change the screen to 'Yes'.

```
Erase All Files
No
```

Step 3 The following screen will now be showing and the 'Yes' will be flashing. Press the \odot key to erase the files.

```
Erase All Files
Yes
```

Step 4 After pressing the \odot key, the screen will display the following message. After about 3 seconds the display will return to the Erase All Files screen.

```
All Erased
```

```
Erase All Files
No
```

All file registers have now been cleared.

Erase Setups

Hint: *This setting is in the Tools menu. To access the Tools menu press the **TOOLS** key and then use the \blacktriangle and \blacktriangledown arrow keys to navigate through the menu items.*

*The HVM100 has the ability to store 10 setups internally in the memory. This is accomplished, as explained later in the manual, by pressing the **STORE** key while in the setup menu. The Erase Setups command is used to clear all of the stored setups from the setup registers.*

To clear all setups:

NOTE: To view each selection, first press the \odot key, and then press the r or l arrow key to scroll through each selection.

Step 1 Go to the Erase Setups menu item.

Step 2 The following screen will appear. Press the \odot key. The 'No' will start to flash. Press the r key to change the screen to 'Yes'.

```
Erase Setups
No
```

Step 3 The following screen will now be showing and the 'Yes' will be flashing. Press the \checkmark key to erase the setups.

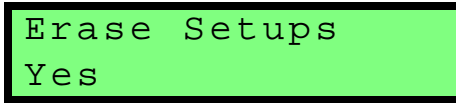

Erase Setups
Yes

Step 4 After pressing the \checkmark key, the screen displays the following message. The display will return to the Erase Setups screen after about 3 to 10 seconds.

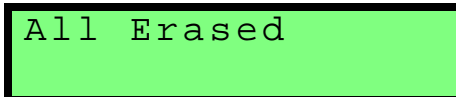

All Erased

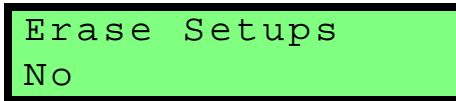

Erase Setups
No

All Setups have now been cleared from the setup registers.

Header 1,2,3

Hint: *This setting is in the Tools menu. To access the Tools menu press the **TOOLS** key and then use the \blacktriangle and \blacktriangledown arrow to navigate through the menu items.*

The HVM100 has 3 Heading information screens. This will allow you to enter descriptive information into the instrument, that will then be printed out with the reports. The information can be up to 16 characters in length in each screen.

To enter information in the Header screens, follow these directions:

NOTE: To change the Header, press the \checkmark key, use the \blacktriangle and \blacktriangledown arrows to select the desired value, and then use the \blacktriangleright and \blacktriangleleft arrows to move to the next position. Once all positions are set press the \checkmark key or move to any other part of the HVM100 to accept the entry.

Step 1 Go to the Header that you wish to change.

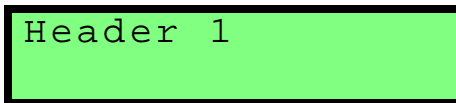

Header 1

Step 2 You will have either a blank screen, or a screen that has previously entered information.

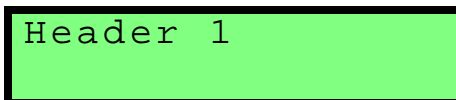

Header 1

```
Header 1
Wilson Processin
```

Hint: You can use the reset key to erase all of the existing entries in an alphanumeric entry. Position the cursor on the Left most position you want erased. Press the R key, and all positions to the right of the cursor, including the cursor position will be erased. If the cursor position is all the way to the left, the entire screen will be erased.

NOTE: The HVM100 will remember the previously selected character as you move positions. If you enter a 'K' in the 1st position, when you use the r or l arrow key to move the next position, you will begin from the 'K'.

Step 3 Use the ◀ and ▶ arrow keys to select the position you want to change, and use the ▲ and ▼ arrow keys to change the character in that position.

Step 4 When you have completed all the entries, press the ⏪ key to return to the Tools menu. You can now move onto the next header (Header 2) by pressing the arrow key.

Language

Hint: This setting is in the Tools menu. To access the Tools menu press the **TOOLS** key and then use the ▲ and ▼ arrow keys to navigate through the menu items.

NOTE: To view each selection, first press the ⏪ key, and then press the r or l arrow key to scroll through each selection.

The HVM100 has the ability to display and print in several different languages. The choices are English, Spanish, Italian, French, German, Portuguese, Czech, and Dutch. Below is an example of one of the language options:

The HVM100 can only store four different languages at one time. Contact The HVM Programmer software can be used to used select and load these languages.

```
Language
```

```
English
```

```
Idioma
```

```
Espanol
```



```
Idioma
```







```
Italiano
```



```
Langage
```

```
Francais
```

Date and Time

Hint: This setting is in the Tools menu. To access the Tools menu press the **TOOLS** key and then use the  and  arrow keys to navigate through the menu items.

NOTE: To change the Date and Time parameter, press the  key, use the  and  arrows to select the desired value, and then use the  and  arrows to move to the next position. Once all positions are set press the  key or move to any other part of the HVM100 to accept the entry.

The date and time functions can be set in this menu. To set the date and time, go to this menu item. Press the  key. You can now make changes just like the alphanumeric menu items in the Header screens. Once all changes have been made, press the  key again to confirm the changes.

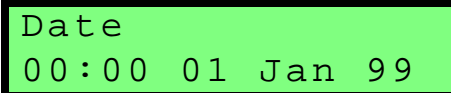

Date
00:00 01 Jan 99

Range Menu

The **RANGE** key functions are concerned with the level of input signals coming into the HVM100.

Range Key

In this menu, Gain is added, Calibration is performed, Auto-Ranging is enabled, and Accelerometer Sensitivity is entered.

Auto Range

Hint: *This setting is in the Range menu. To access the Range menu press the **RANGE** key and then use the \blacktriangle and \blacktriangledown arrow keys to navigate through the menu items.*

The Auto-Range function in the HVM100 is designed to work with a steady state signal, i.e. an object which is vibrating at or near the level of your test object. Often this is the object or subject under test. It should be used prior to starting the actual measurement in order to optimize the input levels from each of the three axes of the transducer's output based on actual vibration levels being produced by the object or subject under test. It is not meant for use while taking data. Before enabling this function, the transducer should be attached to the steady state vibration source to be measured. Next, find the Auto-Range display, located in the Range menu. Press the \odot key to enable auto-ranging. The HVM100 will use its Auto-Range algorithm to adjust the gain for all three channels such that the steady state input signal can be properly measured by the HVM100. (The gain is adjusted so that the signal falls within the top 20 dB of the HVM100's analog to digital converter's range.)

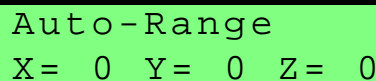

```
Auto-Range
X= 0 Y= 0 Z= 0
```

The selections for the gain will be either 0, 20, 40, or 60 dB.

Once the gain selection is stable, press the \checkmark key to save the settings. The HVM100 must be stopped and reset before the Auto-Range function can be used.

Gain X, Y, Z

Hint: *This setting is in the Range menu. To access the Range menu press the **RANGE** key and then use the \blacktriangle and \blacktriangledown arrow keys to navigate through the menu items.*

A very efficient way to manually set the gain is to have the transducer mounted on the subject under test, as described in the section Auto Range on page 4-1, and check for indications of either under-range, described in the section Under-Range Indicator (?) on page 7-2, or overload, described in the section Overload Detection on page 7-1, and manually adjust the gain as necessary to avoid both.

NOTE: To view each selection, first press the \checkmark key, and then press the r or l arrow key to scroll through each selection.

The Gain settings in the HVM100 will perform manually what the Auto-Range setting did automatically.

You can select one channel at a time, and manually assign a gain setting to that channel. The choices are 0, 20, 40, or 60 dB.

To set the Gain for the X channel, first press the **RANGE** key to open the Range menu. Next press the \blacktriangledown arrow key once to view the Gain X parameter. Press the \blacktriangle and \blacktriangledown to enter the change mode, use the \blacktriangleright or \blacktriangleleft arrow keys to select the desired value, and press the \checkmark key again to confirm the change. The Gain Y and Gain Z displays are located just below the Gain X display. (From the Gain X display press the \blacktriangledown arrow key once to view the Gain Y display. Press the \blacktriangledown arrow key again to view the Gain Z display.)

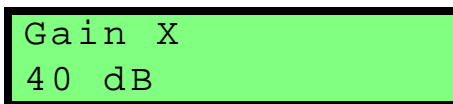

Gain X
40 dB

Cal Level

Hint: *This setting is in the Range menu. To access the Range menu press the **RANGE** key and then use the \blacktriangle and \blacktriangledown arrow keys to navigate through the menu items.*

*NOTE: Calibrators operate at a variety of frequencies. In order to ensure that the frequency weighting selection does not affect the level of the calibration, during calibration the frequency weighting is automatically changed to Fc frequency weighting which applies a bandlimiting filter from 6.3 Hz to 1250 Hz. This is indicated by the display of **Fc** in the upper right of the display during calibration. This should accommodate most vibration calibrators.*

The Cal Level screen will allow you to enter the operating level of your calibrator. The frequency of the calibrator is also important, please see the adjacent note. To enter a value for your calibrator, go to the cal level screen, press the \checkmark key, use the \blacktriangleright or \blacktriangleleft arrow keys to select the position and use the \blacktriangleup and \blacktriangledown arrow keys to change the characters. When the proper level is entered, press the \checkmark key to return to the Range menu. The level must always be entered in g's (rms).

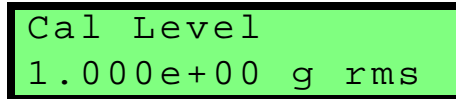

Cal Level
1.000e+00 g rms

During calibration the gain of the HVM100 should also be set so that the level of the calibrator is within the HVM100's measurement range. For example, when using a 1.0 g rms calibrator and an accelerometer with a sensitivity of approximately 100mV/g, the gain should be set to 20 dB. For a 10 mV/g accelerometer, the gain should be set to 40 dB. A gain of 60 dB is appropriate for a 1 mV/g accelerometer. See appendix A for a complete listing of the HVM100's measurement range.

Calibrate X, Y, Z

Hint: *This setting is in the Range menu. To access the Range menu press the **RANGE** key and then use the \blacktriangleup and \blacktriangledown arrow keys to navigate through the menu items.*

NOTE: To change the Cal Level parameter, press the \checkmark key, use the up and down arrows to select the desired value, and then use the \blacktriangleright and \blacktriangleleft arrows to move to the next position. Once all positions are set press the \checkmark key or move to any other part of the HVM100 to accept the

The calibrate screens are used to calibrate individual channels using a calibrator attached to the accelerometer. To calibrate the HVM with the accelerometer's published sensitivity, see the next section in this manual. To calibrate:

- Step 1** Enter the menu for the channel you wish to calibrate.
- Step 2** Make sure the transducer for channel X is firmly attached to the calibrator. If using a tri-axial transducer (e.g. SEN02, SEN027, etc.) be sure the transducer is properly oriented for the axis you wish to calibrate.
- Step 3** Start the calibrator.

During stabilization (i.e. after the \checkmark key has been pressed once), the calibration can be cancelled by pressing the on/off key.

NOTE: After a given channel has been calibrated using the shaker type calibrator, the HVM100 calculates the sensitivity of the attached accelerometer. To view the sensitivity please see the next section in this manual.

Step 4 Press the \checkmark key on the HVM100. The screen will start to flash values. When the level of your calibrator appears in the screen, and the reading is stable, press the \checkmark key again.

This will calibrate channel X of the HVM100. Repeat the procedure for the channels Y and Z. The Calibrate Y and Calibrate Z displays are located just below the Calibrate X display. (From the Calibrate X display press the d arrow key once to get to the Calibrate Y display, and press the d arrow key again to get to the Calibrate Z display.)

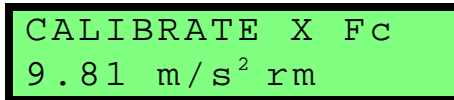

CALIBRATE X Fc
9.81 m/s² rm

NOTE: If the integration setting is set to single or double, the HVM100 will not calibrate using a calibrator. Specifically, the Cal Level, Calibrate X, Calibrate Y, Calibrate Z menu items will not be displayed.

Sensitivity X, Y, Z

Hint: *This setting is in the Range menu. To access the Range menu press the **RANGE** key and then use the \blacktriangle and \blacktriangledown arrow keys to navigate through the menu items.*

Another method of calibrating the HVM100 is to use the published sensitivity of the accelerometer. This is accomplished through the Sensitivity menu item.

NOTE: To change the Sensitivity parameter, press the \checkmark key, use the \blacktriangle and \blacktriangledown arrows to select the desired value, and then use the \blacktriangleright or \blacktriangleleft arrows to move to the next position. Once all positions are set press the \checkmark key or move to any other part of the HVM100 to accept the entry.

To enter the sensitivity of the accelerometer, go to the menu item for the desired channel. Press the \checkmark key to enter the change menu, use the \blacktriangleright or \blacktriangleleft arrow keys to select the position you wish to change, and the \blacktriangle and \blacktriangledown arrow keys to change the characters.

Note: the sensitivity values are entered using scientific notation, e.g. a transducer with a sensitivity of 100.2 mV/g would be entered as $1.002e^{+2}$ mV/g.

When the correct sensitivity has been entered, press the \checkmark key to confirm the change. The entry procedure is the same for all channels, and the screens will look the same. The

units for ICP® and Direct are mV/g (rms), the units for charge accelerometers are pC/g (rms).

```
Sensitivity X
1.000e+2 mV/g
```

Reference Acceleration

Hint: *This setting is in the Range menu. To access the Range menu press the **RANGE** key and then use the \blacktriangle and \blacktriangledown arrow keys to navigate through the menu items.*

NOTE: To view each selection, first press the \odot key, and then press the r or l arrow key to scroll through each selection.

The HVM100 uses the following reference values to display acceleration, velocity and displacement in dB units:

- Acceleration 10^{-6} m/s²
- Velocity 10^{-9} m/s,
- Displacement 10^{-12} m

The following reference values are also available for the user to select:

- Acceleration 10^{-5} m/s²
- Velocity 10^{-8} m/s
- Displacement 10^{-11} m

```
dB re
10e-5 m/s2
```

Hand Arm Exposure Action Value

Hint: *This setting is in the Range menu. To access the Range menu press the **RANGE** key and then use the up and down arrow keys to navigate through the menu items.*

NOTE: To view each selection, first press the \odot key, and then press the r or l arrow key to scroll through each selection.

The Hand Arm exposure action value default is 2.8 m/s², but it can be changed to 2.5, 4.0 or 5.0 m/s². While this value can be changed in any mode, it is only used for calculating exposures in Hand Arm mode.

Exposure re.
2.8 m/s²

NOTE: The United Kingdom specified the 2.8 m/s² action value for single axis measurements (X, Y or Z). The Physical Agents Directive (2002/44/EC) for the European Union calls for a measurement of the vector sum of all three axes (Σ). In this directive, 2.5 m/s² is specified as the action level and 5.0 m/s² as the maximum allowable exposure limit.

Printing

The **PRINT** key is the most efficient method for downloading data from the HVM100. Pressing the **PRINT** key will cause the HVM100 to stream formatted ASCII text to the instrument's serial port connector.

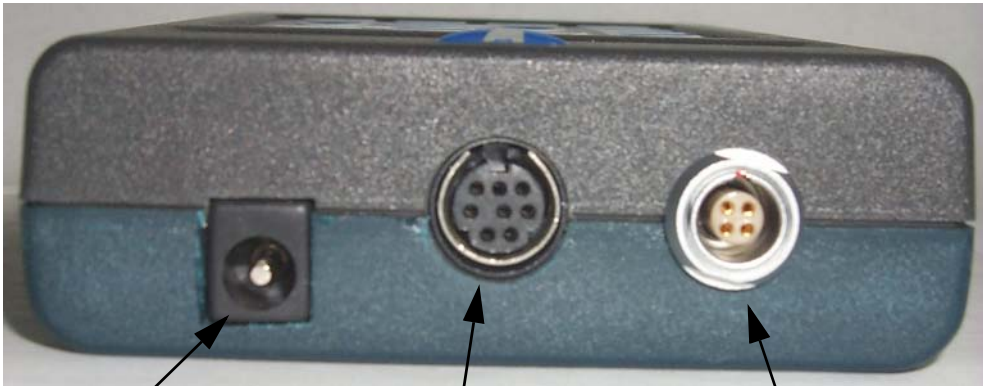

External Power

Serial Port

Input Connector

NOTE: The print key only works if you are currently in the History or Data menu.

Only the current data in the HVM100 can be printed. To print a stored data file, first recall the data file from memory using the recall key, and then go through the printing process.

Printing to a Windows Hyperterminal

Note that Vista doesn't have a serial terminal. If one is needed to replace the functionality of HyperTerminal then there are several available for download, one of which is PuTTY

If using Window XP, another option for retrieving data from your HVM100 is printing to a Windows hyperterminal connection. Hyperterminal is a Windows application that is included with every version of Windows XP. This is an optional installation item, and may not have been installed if a custom installation of Windows was performed. This option will allow you to print the text into the Hyperterminal screen, and then cut and paste text into a word processing or spreadsheet application.

To print to a Hyperterminal connection:

Step 1 Collect the data in the HVM100.

Step 2 Use the Print History setting (located in the Tools menu), to select whether or not to include Time History data in the printed report.

Step 3 Connect CBL006 to the I/O port on the HVM100, and to the communications port on your computer.



Step 4 Locate Hyperterminal on your computer. Hyperterminal is usually found in the Start menu, under Programs, and in the Accessories folder.

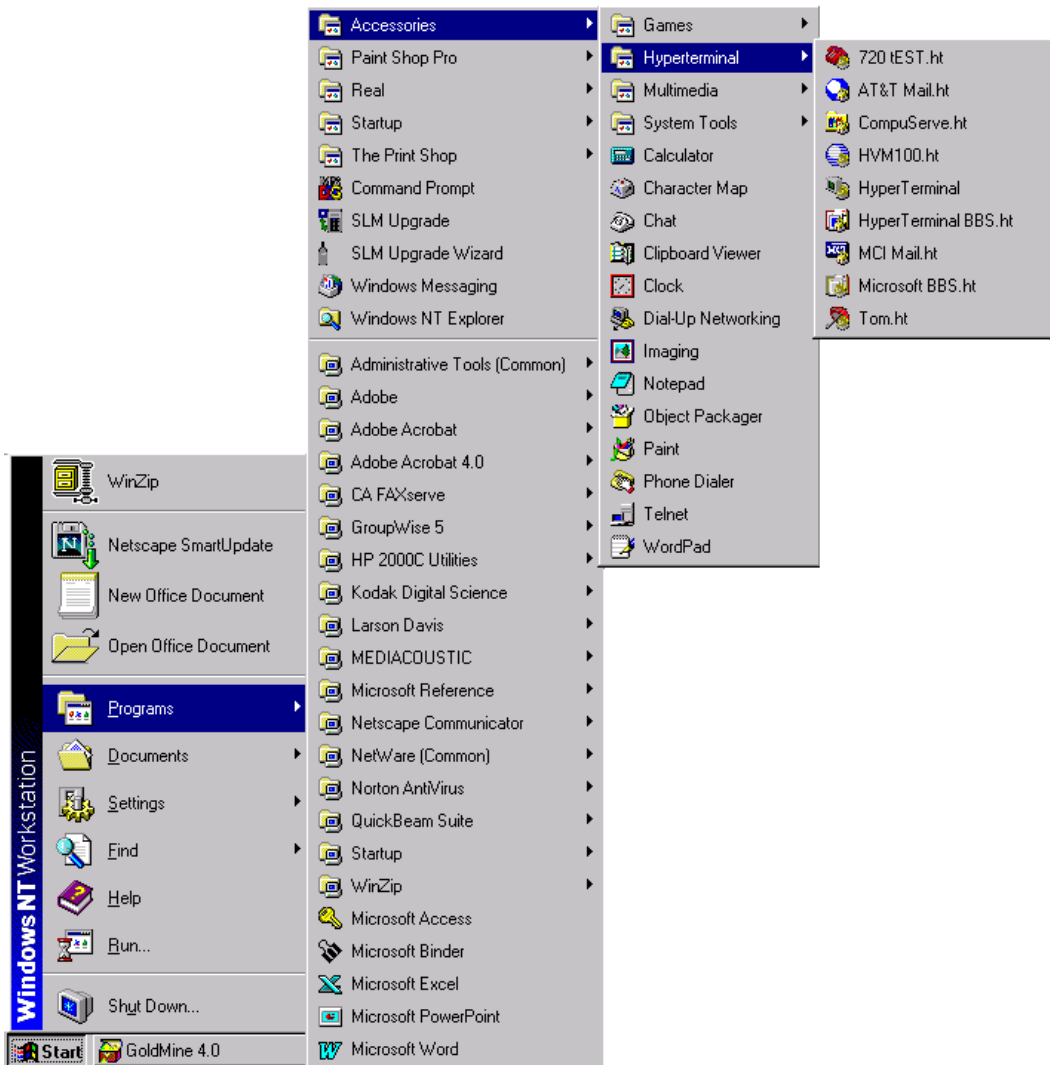

Step 5 Select Hyperterminal from the menu. A new connection dialog box will appear.

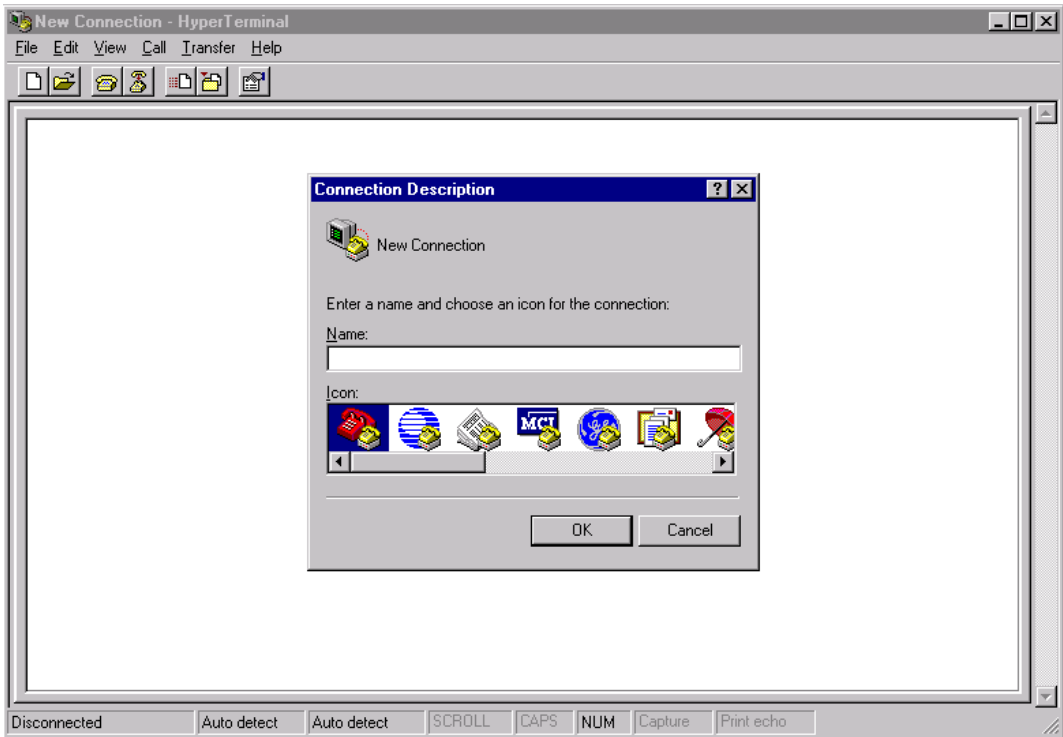

Step 6 Enter a name, and choose an icon for your Hyperterminal connection.

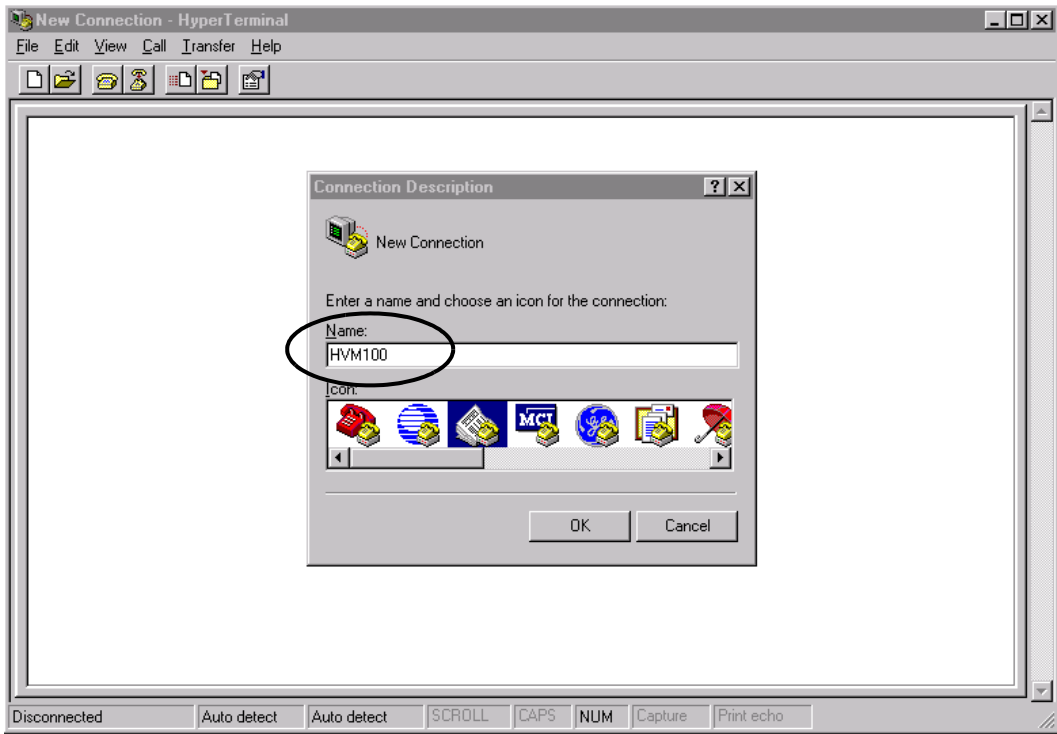

Step 7 Press the OK button.

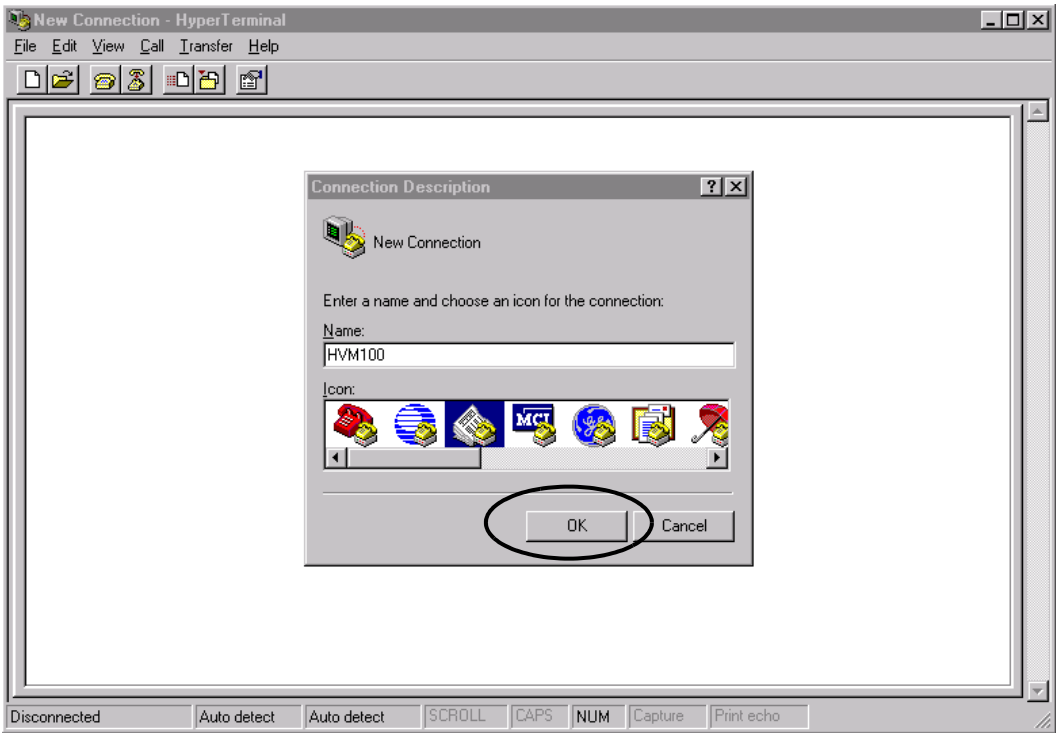

Step 8 The Connect to dialog box will appear.

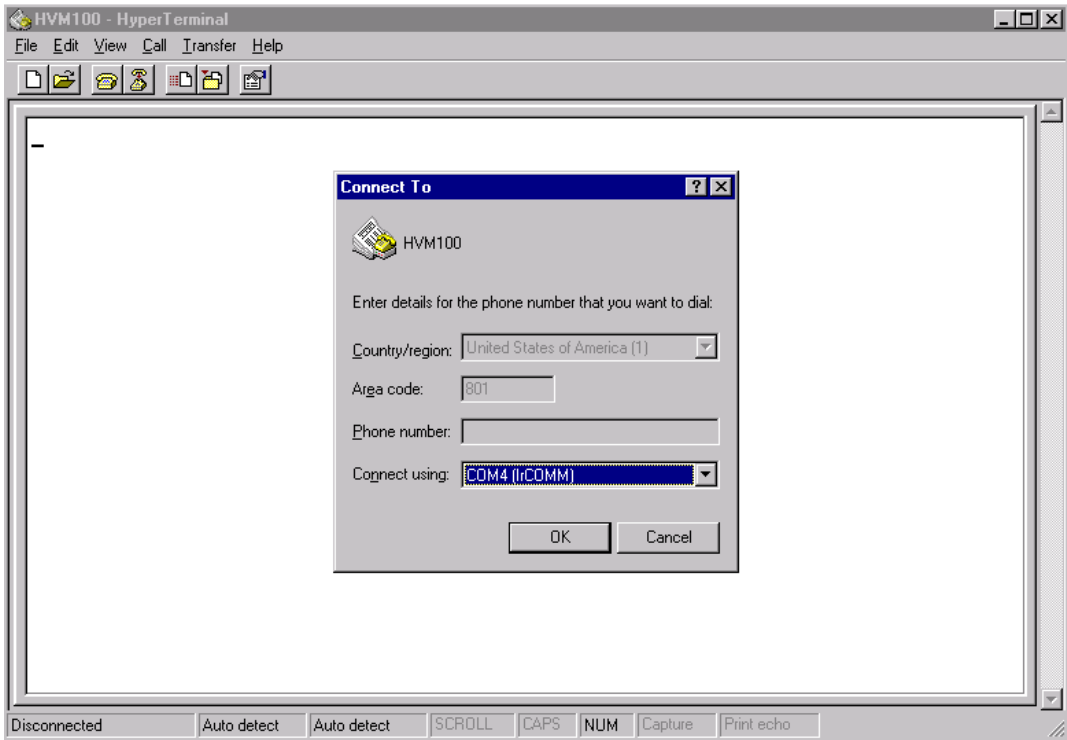

Step 9 The last selection in this box is the ‘Connect using’ selection box. This will allow you to select the Com port you will use to communicate with the HVM100. Select the Com port you plugged your HVM100 into. Press OK.

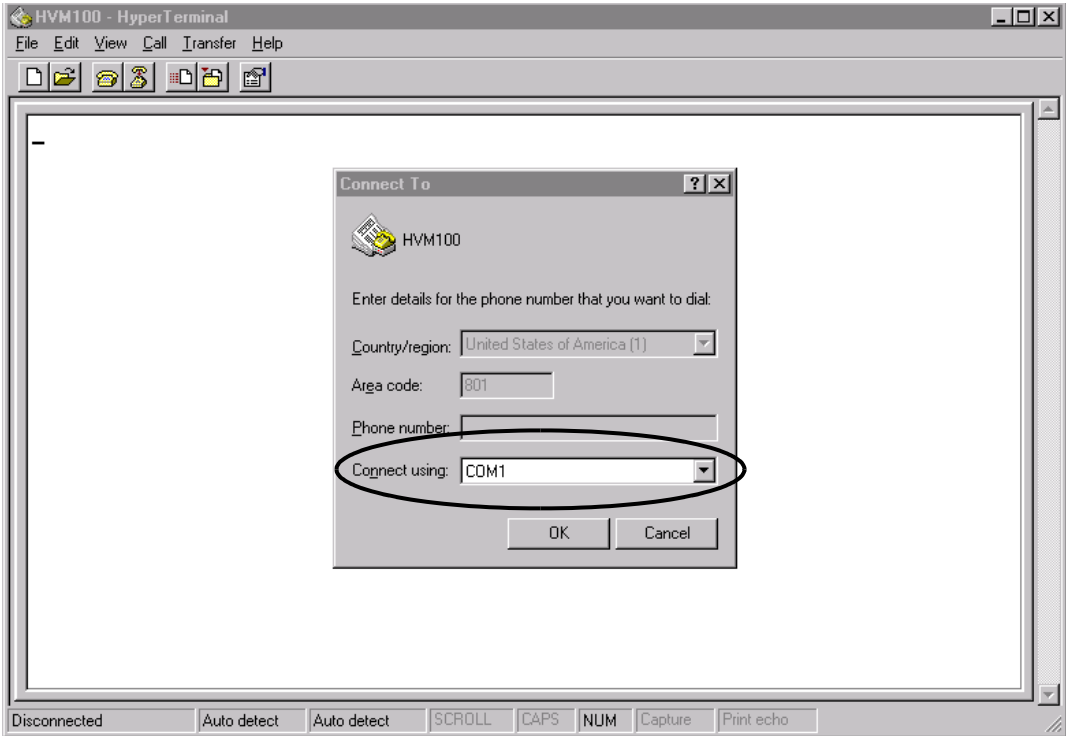

Step 10 The Communications properties screen will appear. Select the Baud rate (bits per second) that matches the baud rate on your HVM100. The other settings are:

- Data bits: 8
- Parity: None
- Stop Bits: 1
- Flow Control: Hardware

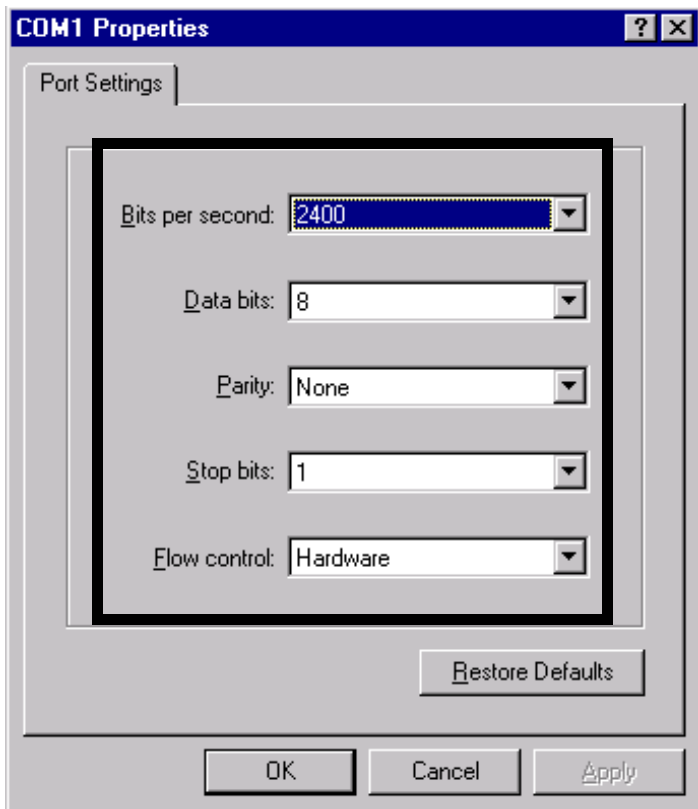

Step 11 Press the OK button.

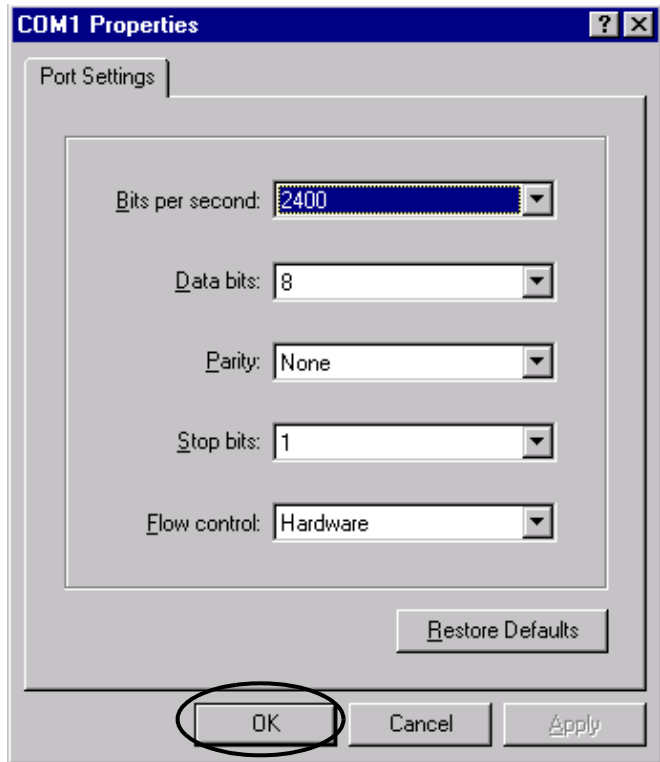

You have now established a connection for the HVM100. You will notice that in the lower left corner of the Hyperterminal screen it states that there is a connection, and will show how long the connection has been in place.

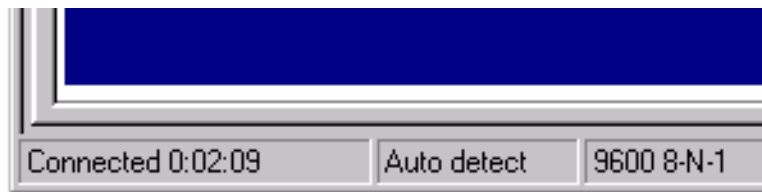

Left click the **Properties** button

Properties

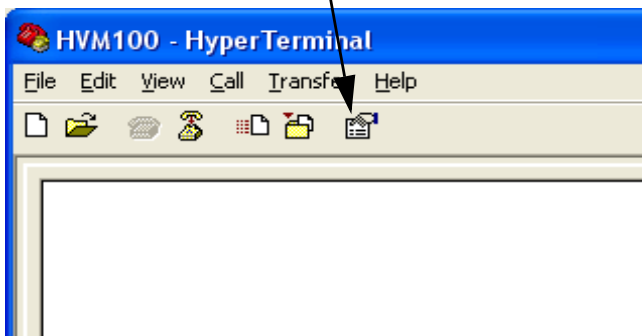

Settings

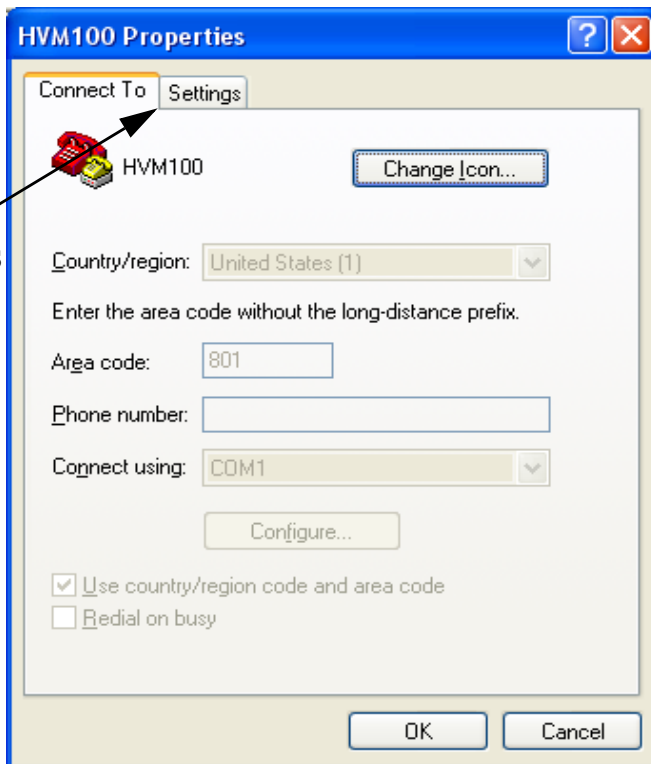

Left click the **Settings Tab** at the top of the window to open the **Setting** dialog box.

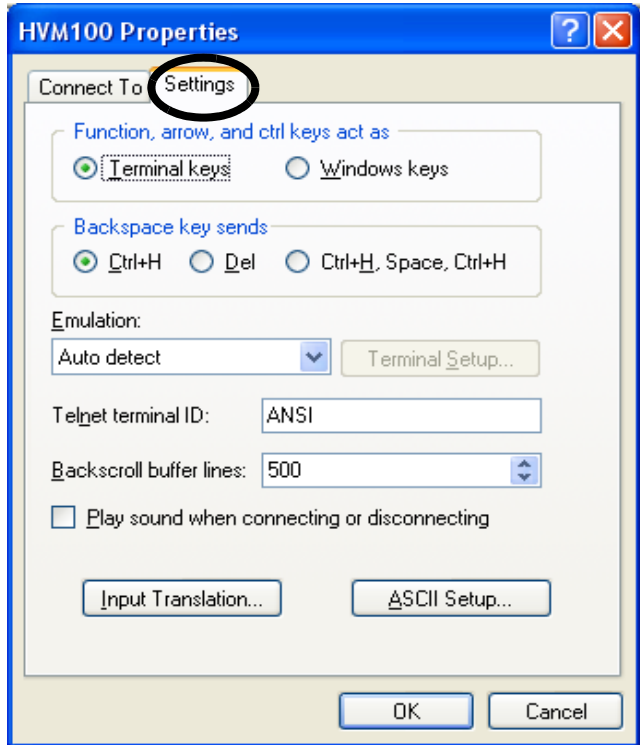

Configure the items as shown above and click **ASCII Setup** to open the ASCII dialog box.

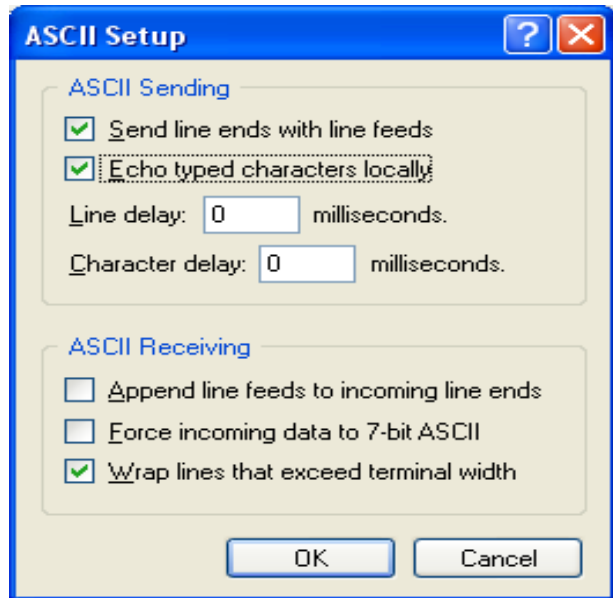

Configure the items as shown above and press **OK** to close the ASCII dialog box.

Press **OK** to close the **Properties** window.

Left click **Transfer** box which will open the following dialog box.

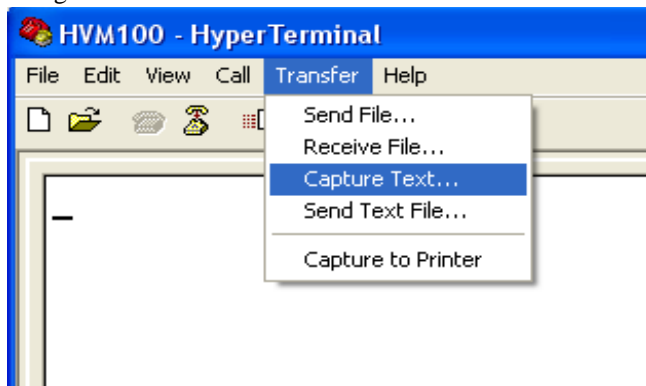

Highlight **Capture Text** and left click.

This will open the following menu

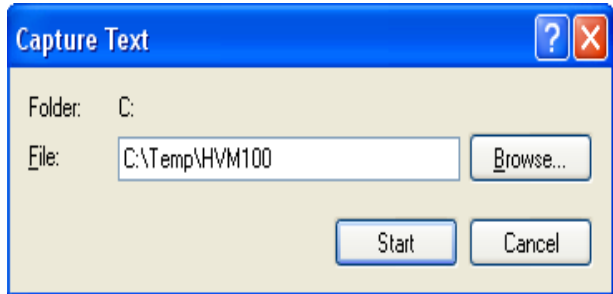

Use the Browse function to identify the file into which you want the data transferred and press **Start**.

After the connection has been established, press the **PRINT** key on the HVM100



Left click **Transfer**, highlight **Stop** on the drop-down menu and left click.

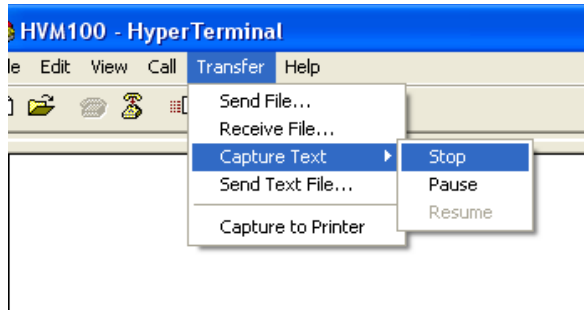

The data can now be found as a Test file in the folder designated for saving the transferred file.

```

test1.TXT - Notepad
File Edit Format View Help
Larson Davis HVM100 SN:04018 rev 1.20 Page 01

000000000000000000000000
000000000000000000000000
000000000000000000000000

Time of Measurement : 21 Mar 03 14:21:46
Report Printed : 21 Mar 03 14:25:19

-----
SETUP for :HandArm Test S0

Operating Mode : Hand Arm
Averaging : SLOW Store Time hh:mm : 00:04
2nd History : Peak Auto Store : Autostop
Accelerometer : ICP Integration : None

Weighting X: Wh Hand Arm Y: Wh Hand Arm Z: Wh Hand Arm
Sum Factor Y: 1.00 Z: 1.00
Gain X: 40 Y: 40 Z: 40
Sensitivity X: 1.024e+00 mv/g Y: 1.008e+00 mv/g Z: 1.035e+00 mv/g

AC/DC output X: AC: weighted Y: AC: weighted Z: AC: weighted

-----
DATA for :HandArm Test S0

Run Time : 0:00:20

Value Channel X Channel Y Channel Z sum Units
-----
Arms 3.000 2.670 1.030 4.130 m/s^2
Amin .0895 .1220 1.0300 1.1500 m/s^2
Amax 10.900 8.370 4.540 13.000 m/s^2
Peak .453 .738 .405 .829 m/s^2
Aeq 7.130 4.910 2.470 8.980 m/s^2
Amp 26.400 16.700 10.300 29.900 m/s^2
A(1) .532 .366 .184 .670 m/s^2
A(2) .376 .259 .130 .474 m/s^2
A(4) .266 .183 .0921 .3350 m/s^2
A(8) .1880 .1290 .0651 .2370 m/s^2
Exp Time 1.2 2.6 10.2 0.7 Hours
0
Larson Davis HVM100 SN:04018 rev 1.20 Page 02

```

Storing and Recalling Data Files and Setups

This chapter will describe the process of storing data and setup information in the HVM100's internal memory.

STORE Key

The **STORE** key on the HVM100 has two functions. It will allow you to store data files, and setups. The functionality is determined by the menu you are currently viewing. If you press the store key while you are viewing the Data or History menu, you will be prompted to store a file. If you press the **STORE** key while you are in the Setup, Range, or Tools menu, you will be prompted to store a setup.

Storing a Setup

The HVM100 will allow you to store up to TEN unique setups; these are assigned setup file registers labeled beginning with S0 up to S9. You may choose any of these registers to store a setup.

To store a setup,

Step 1 Enter the Setup, Tools or Range menu by pressing the **SETUP**, **RANGE** or **TOOLS** key (as in this illustration).

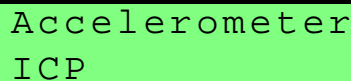

```
Accelerometer
ICP
```

Step 2 Press the **STORE** key.

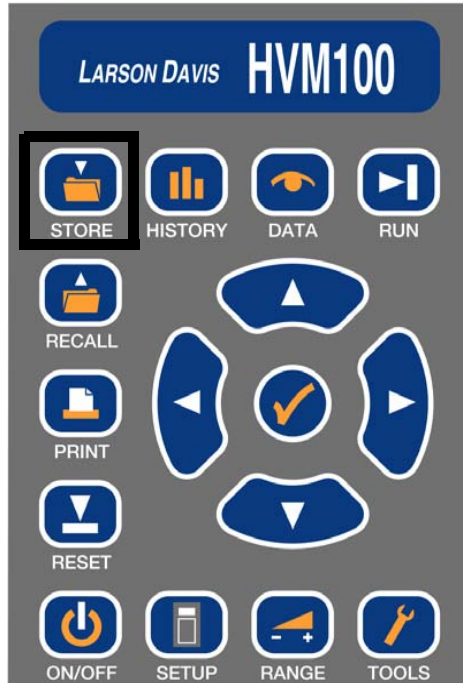

Step 3 The display will prompt you to store a setup. The flashing number in the lower right corner is referring to the setup register you are currently selecting.

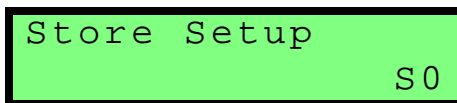

NOTE: To purge all setup registers, go to the Tools menu, use the ▲ and ▼ arrow keys to select the Erase Setups selection. Press the ✓ key, use the ← arrow key to change the selection to Yes, and press the ✓ key again.

Step 4 Select a setup register by pressing the ▲ and ▼ arrow keys until the desired selection appears.

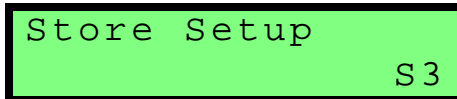

Step 5 Press the **l** arrow key to scroll to the naming section of the screen. You can now enter a name for the setup. Use the **▲** and **▼** arrows to select characters for the positions and the **▶** and **◀** arrow keys to move to the different positions.

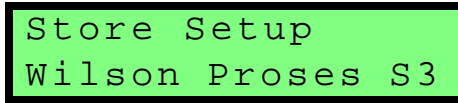

Step 6 Press the **✓** key. This will store the setup in the selected register and then place you back into the menu from which you started.

To recall a setup from the setup register, see the next section in this manual on the **RECALL** key.

Storing a File

To store a data file,

Step 1 Press the **DATA** or **HISTORY** keys to enter a screen where data is being displayed.



Step 2 Press the **STORE** key.

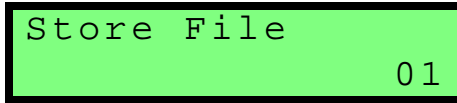

Step 3 The Store File screen will appear. The number in the bottom right of the screen is referring to the file register where the data will be stored.





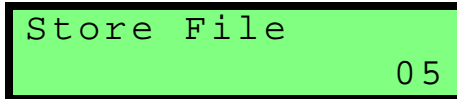

```
Store File
01
```

Step 4 Use the  and  arrow keys to select the desired file register.









```
Store File
05
```

Step 5 Press the  arrow key to scroll over to the naming section of the screen. You can now enter a name for the data file. Use the  and  arrows to select characters for the positions and the  and  arrow keys to move to the different positions.



```
Store File
Wilson Proses S5
```

NOTE: To purge all data files, go to the Tools menu, use the  and  arrow keys to select the Erase All Files selection. Press the  key, use the  arrow key to change the selection to Yes, and press the  key again.

Step 6 Press the  key. The current data has now been stored in the selected register. The data file will also contain all of the setup information that corresponds to that data file. When the data file is recalled, all of the setup information can also be viewed. The data can now be reset, and the stored data will not be lost.

To recall a data file into the current memory, see the next section on the **RECALL** key.

Temporary Data Storage - File Register 00

File register 00 is normally used as a temporary data storage location. For example, if there is un-stored data in the HVM100 and the off key is pressed, the following screen will appear.

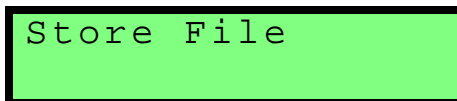

```
Store File
```

Select “No” to turn off the HVM100 without saving. Select “Abort” to cancel the request to turn off. Select “Yes” to

store the HVM100's current data and setup in file register 00, and then turn off.

Data Storage - File Registers 01 thru 99

Once all files have been purged (see chapter 3, Tools Menu), automatic and manual storing of files begins with file register 01. For example, if all files have been purged and there is data in the HVM100, pressing the **DATA** key, followed by the **STORE** key, will cause the following screen will appear (note, the file register shown will be 01).



```
Store File
```

If all files have been purged, and the Auto Store feature is enabled (see chapter 2, Getting Started), the HVM100 will automatically store the first file in file register 01. The second file will be automatically stored in file register 02 and so on until all 99 file registers are full.

Preserving the File Counter At Power-Off

The file counter, which keeps track of the last file register used, is saved when the HVM100 is turned off. For example, suppose you store 10 files in file registers 01 thru 10. Then, you turn off the HVM100. When the HVM100 is turned on again, if you try to store data, the HVM100 will prompt you to store data in file register 11, which is the next empty file register (see screen below).

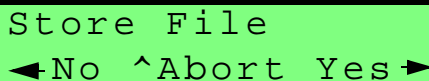

```
Store File  
◀No ^Abort Yes▶
```

A separate counter is used when you recall files. For example, suppose you recall and view files 01 thru 05. Then, you turn off the HVM100. When the HVM100 is turned on again, if you try to recall a file, the HVM100 will prompt you to recall file register 06, which is the next available file to view (see screen below).

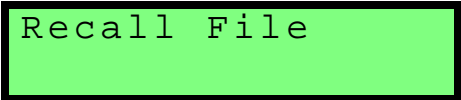

```
Recall File
```



Recall Key

In order to use a setup, or to print a stored file they must be recalled into the current memory of the HVM100. The **RECALL** key is again dependent on the menu being viewed when the key is pressed. If you are in the Tools, Setup or Range menu and press the **RECALL** key, you will be prompted to recall a setup. If you are in the Data or History menu you will be prompted to recall a data file.

Recalling a Setup

To recall a setup,

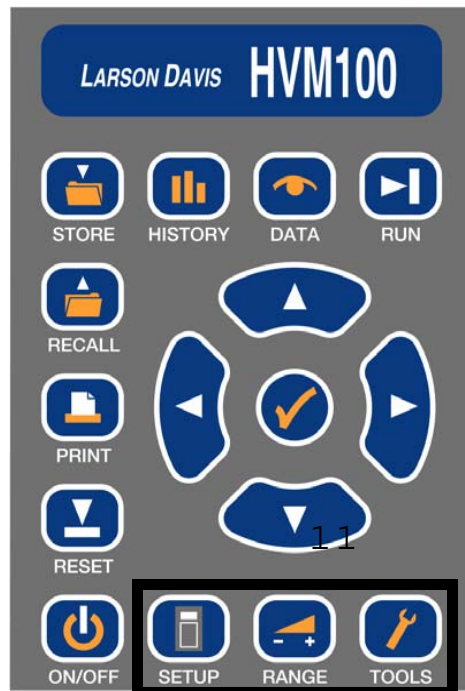
- Step 1** Enter one of the three valid menus for recalling a setup. The Range menu, the Setup menu, or the Tools menu.



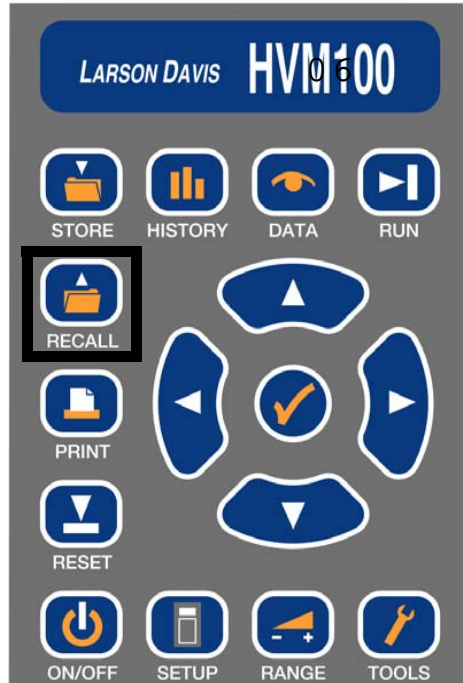

Step 2 Press the **RECALL** key.

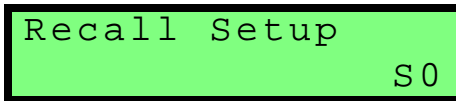

Step 3 You will now be prompted to recall a setup.



Step 4 Use the  and  arrow keys to scroll through the setups until the desired setup appears on the screen.

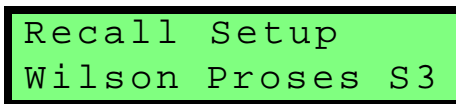

Step 5 Press the  key to recall the setup.

Recalling Setup Register S0 at Power-On

Setup register S0 is defined as the HVM100's boot setup. In other words, whenever the HVM100 is turned on, it will automatically recall setup register S0. Therefore, you can configure your HVM100 as desired, save the setup to

register S0, and the HVM100 will automatically recall that setup every time the HVM100 is turned on.

If for some reason, the HVM100 needs to be reset to its original factory default settings, the user can erase all setup registers (see chapter 3, Tools Menu). This will reset all setups, including setup register S0, to their factory defaults.

Recalling a File

To recall a stored data file,

Step 1 Press the **DATA** or **HISTORY** key to enter the Data or History menu.

Step 2 Press the **RECALL** Key on the HVM100.

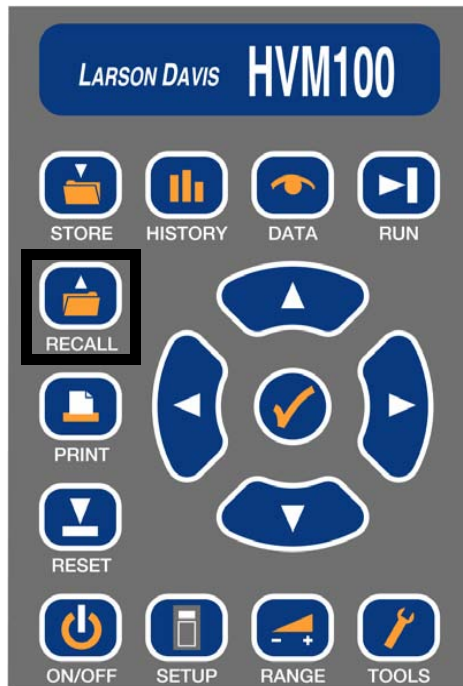

Step 3 The screen will prompt you to recall a file.

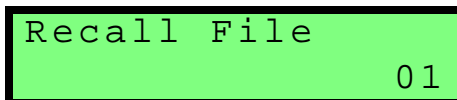

Step 4 Use the ▲ and ▼ arrow keys to move to the desired selection.

```
Recall File  
Wilson Proses 05
```

Step 5 Press the Ⓢ key to recall the file into the current memory. All setup information was stored when the data file was stored. That setup information is recalled with the data file, and can be reviewed.

Taking Measurements/ Viewing Data on the HVM100

This chapter will describe how to take a measurement and view the data on the display of the HVM100.

Run/Stop Key

The Run/Stop key is used to start and stop the measurement. There are several screen indicators that will appear as this key is pressed.

Screen Symbol	Definition
■	Run Indicator. Also indicates the level of the input signal coming into the HVM100. The bar graph is drawn in approximately 5 dB steps.
?	Under Range Indicator.
	Stop Indicator. Indicates that the HVM is not running.
*	Latching Overload Indicator.
!	Run - Interrupted Indicator

Overload Detection

When an overload occurs on the HVM100 the meter will perform three functions for the overloaded channel.

- The HVM100 indicates when an overload is currently occurring on any of the three inputs. The HVM100 flashes the following screen.

```
Over *
                Z          F c X
```

- The HVM100 uses an * to indicate that an overload has occurred since the last reset. The * is displayed on all channels regardless of which channel was overloaded. The Amp value on the overload channel will display “OVER”

```
Peak .00988 *
Amp  OVER          F c Z
```

- Short Term values like Arms, Peak, Time History values etc. will be reported as OVER whenever an overload corrupts these values.

```
Peak OVER
Amp  OVER          F c Z
```

Under-Range Indicator (?)

The under-range indicator will replace the bar graph run indicator whenever the channel currently displayed is under-range. The under-range indicator, like the bar graph, is independent for all three channels. A channel is under range whenever the input rms signal level is below the minimum RMS Range level as specified in the Typical Measurement Range tables in Appendix A. For example, with 0 dB gain, if the input rms level drops below 74 dB μ V (5 mV), the under-range indicator will be displayed.

Run-Interrupted Indicator (!)

If the HVM100 is stopped and then run again without resetting the current data, the run-interrupted indicator (!) will replace the colon (:) in all displays that show the run time. The “!” indicates that the data in the HVM100 is not contiguous. In other words, the instrument was stopped one or

more times during the collection of the data. An example of a data display with the “!” indicator is shown below.

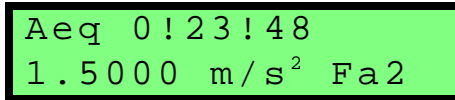

```
Aeq 0!23!48
1.5000 m/s2 Fa2
```

History Key

NOTE: To view each selection, first press the ⏴ key, and then press the r l u or d arrow key to scroll through each selection.

The HVM100 will store a time history based on the sample time selected. The Time History buffer has 240 entries available for storage. If you select to store the Peak values as well as the RMS values, the number of time history records is cut in half to 120.

NOTE: The 2nd History setting (located in the Setup menu), controls whether or not the Peak levels are stored in the Time History.

Example: You have selected an Averaging time of Slow. This Averaging time selected is the one second exponential detector, and if the 2nd History selection in the Setup menu is set to none, you will be able to store for 240 seconds. After 240 seconds the history will start erasing the data from the beginning of the Time History buffer to make room for the incoming data. If the 2nd History selection is set to Peak, then you will have 120 seconds of storage time, and after that, the Time History buffer will begin to erase from the beginning to make room for the new data.

The **HISTORY** key works much the same as the other menus in the HVM100. To view the Time History data, press the **HISTORY** key.

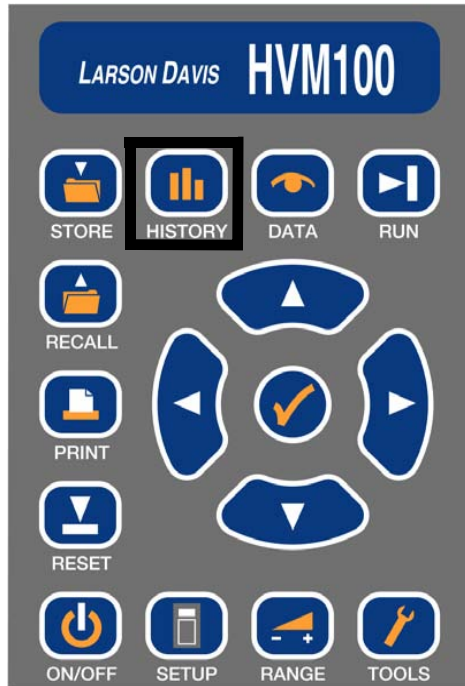

You will now be presented with the history data from the first history record. The data is presented in the following format:

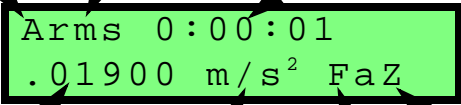
<p>The first letter indicates the integration selected. A=acceleration</p>	<p>This is the value being displayed. The choices are rms or Peak.</p>	<p>This is the run time for the currently displayed Time History record. This will always be a multiple of the Averaging Time.</p>
		
<p>Measured value.</p>	<p>Display Units.</p>	<p>Channel</p>
<p>Frequency Weighting</p>		

Use the ▲ and ▼ arrow keys to select additional history records, and use the ► and ◀ arrow keys to select data from the different channels.

```
Arms 0:00:04
.01900 m/s2 FaZ
```

u

```
Arms 0:00:03
.01900 m/s2 FaZ
```

u

```
Arms 0:00:02
.01900 m/s2 FaZ
```

u

```
Arms 0:00:01
.01900 m/s2 FaZ
```

Viewing Time History with 2nd History turned on

If the 2nd history selection is turned on, the History buffer will alternate between RMS and Peak values for each record.

```
Peak 0:00:02
4.3800 m/s2 FaZ
```

u

```
Arms 0:00:02
1.5000 m/s2 FaZ
```

u

```
Peak 0:00:01
4.3800 m/s2 FaZ
```

u

```
Arms 0:00:01  
1.5000 m/s2 FaZ
```

Data Key

NOTE: To view each selection, first press the \odot key, and then press the r lu or d arrow key to scroll through each selection.

The **DATA** key is used to view the overall data being gathered by the instrument. There are 8 screens available in the data menu. To scroll through the menu, use the \blacktriangle and \blacktriangledown arrow keys. To view other channels use the \blacktriangleright and \blacktriangleleft arrow keys. The screens are formatted as follows.

Data Presented	Screen appearing on the HVM100
Top screen reports Time and Date. It will also report the last recalled setup, or data file name, which ever was more recent.	Process Batch 03 19:34 03 Oct 99
2nd screen reports detector and averaging time on first line (A=acceleration) and RMS level, units, frequency weighting and channel on second line.	Arms 10 sec 3.5700 m/s ² FaZ
3rd screen reports minimum level on first line, and maximum level on second line. Frequency weighting and channel are also reported.	Amin .00000 Amax .01430 FaZ
4th screen reports Peak level on first line and the long term maximum peak level on the second line. Frequency weighting and channel are also reported.	Peak .04780 Amp .09550 FaZ
5th screen reports the long term average that runs from run to reset and averaging time on first line. Value, units, frequency weighting and channel on the second line.	Aeq 0:00:01 03 1.5000 m/s ² FaZ

Additional Data view screens for Hand Arm Mode	
The 6th and 7th screens report the Energy Equivalent levels averaged over the run time. 1, 2, 4, and 8 refer to the run time in Hours. (A (8) is the Energy Equivalent level projected over 8 hours)	<pre>A (1) . 00104 A (2) . 00073 FaZ</pre>
The Frequency weighting and channel are also reported.	<pre>A (4) . 00052 A (8) . 00036 FaZ</pre>
The 8th screen shows the Allowed Exposure Time based on the measured A(8) value and a criterion level of 2.8 m/s ² .	<pre>A (8) Exposure</pre>
The 9th screen is the Points display for the Hand Arm Mode before taking a measurement. It will appear as shown to the right before taking a measurement. The display axis automatically switches to Sum (sigma). If the user scrolls back out of this display, the HVM100 remembers what the display axis was and restores it. The bar at the top right indicates that the meter is stopped.	<pre>PE 0:00:00 : (8) : Σ</pre>
While taking a measurement, the Points display for the Hand Arm Mode will appear as show to the right. The measurement time appears on the top line, the number of points accumulated during the test period is displayed on the lower left (2 in this example) and the 8-hour equivalent is displayed on the lower right as indicated by the (8). Both fields are limited to four characters. The black rectangle indicates that the measurement is in progress.	<pre>PE 0:00:53 ■ : 2 (8) : 878</pre>

:

Additional Data view screens for Hand Arm Mode	
When the measurement is finished, the Points display for the Hand Arm Mode will appear as show to the right. The bar symbol in the upper right changes to the standard “stopped” symbol.	<pre> PE 0 : 01 : 00 : 2 (8) : 878 Σ </pre>
Note that both the points accumulated during the test and the 8-hour equivalents are limited to 4 characters. To prevent erroneous data from being displayed (i.e. 20456 appearing as 0456), the value will never be allowed to exceed 9999. The saturation condition is indicated by the colon changing to a greater-than symbol as shown to the right.	<pre> PE 0 : 01 : 00 : 2 (8) : >9999 Σ </pre>

Additional Data view screens for Whole Body Mode	
The 1st screen is the Points display for the Whole Body Mode before taking a measurement. It will appear as shown to the right before taking a measurement. The display axis automatically switches to Sum (sigma). If the user scrolls back out of this display, the HVM100 remembers what the display axis was and restores it. The bar at the top right indicates that the meter is stopped.	<pre> PE 0 : 00 : 00 : (8) : Σ </pre>
While taking a measurement, the Points display for the Whole Body Mode will appear as show to the right. The measurement time appears on the top line, the number of points accumulated during the test period is displayed on the lower left (2 in this example) and the 8-hour equivalent is displayed on the lower right as indicated by the (8). Both fields are limited to four characters. The black rectangle indicates that the measurement is in progress.	<pre> PE 0 : 00 : 53 : 2 (8) : 878 Σ </pre>
When the measurement is finished, the Points display for the Whole Body Mode will appear as show to the right. The bar symbol in the upper right changes to the standard “stopped” symbol.	<pre> PE 0 : 01 : 00 : 2 (8) : 878 Σ </pre>

Additional Data view screens for Whole Body Mode	
Note that both the points accumulated during the test and the 8-hour equivalents are limited to 4 characters. To prevent erroneous data from being displayed (i.e. 20456 appearing as 0456), the value will never be allowed to exceed 9999. The saturation condition is indicated by the colon changing to a greater-than symbol as shown to the right.	PE 0:01:00 I : 2(8):>9999 Σ
The Vibration Dose Value and run time are displayed on the first line. The value, units, frequency weighting, and channel are displayed on the second line.	VDV 0:00:00 2.9700 m/s ^{7/4} WbZ
Short Term Crest Factor is shown on the first line, the Long Term Crest factor is reported on the second line. The Frequency weighting and channel are also reported.	CF 20.3dB CFmp 21.0dB WbZ

NOTE: The vibration dose value (VDV), specified by ISO 8041:2005 and calculated by the HVM100, has units of m/s^{7/4}. The HVM100 is also capable of displaying VDV in cm/s^{7/4}, ft/s^{7/4}, or in/s^{7/4} (using the Display Units parameter). However, if Display Units are set to "g" or "dB", the VDV becomes an undefined quantity. Therefore, if the display units are "g" or "dB", the HVM100 will display a series of dashes (-----) for the value.

NOTE: The Short-Term Crest factor (CF) is not calculated if the Averaging Time setting is SLOW

Please see the specifications appendix for further information regarding specifics of all measured values.

Powering the HVM100

Batteries

The HVM100 operates on 2 AA batteries. See Appendix A for information on typical battery life.

Checking the Remaining Battery Voltage

The battery voltage can be viewed from the data menu by pressing the \checkmark key. The following screen will be displayed.

```
Battery 1.1V
External 12.2V
```

When the batteries have approximately five minutes of life remaining, the HVM100 will begin flashing a letter 'B' in the upper right corner of the display.

Installing New Batteries

To install new batteries in the HVM100,

Step 1 Remove battery cover from the side of the case.



Step 2 Remove old batteries.



Step 3 Arrange new batteries according to diagram on the inside of the case. Make sure polarity of the batteries is correct.

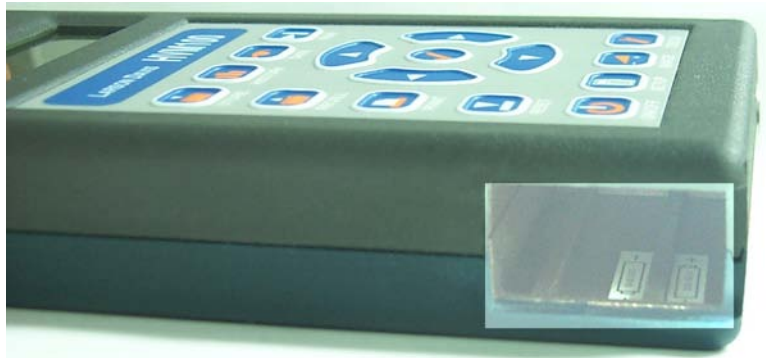

Step 4 Gently push the new batteries in the case while pushing the battery cover over the battery opening.



Using External Power

The HVM100 can also operate on 7 to 30 Volts DC external power. The external power connector is on the top of the HVM100.

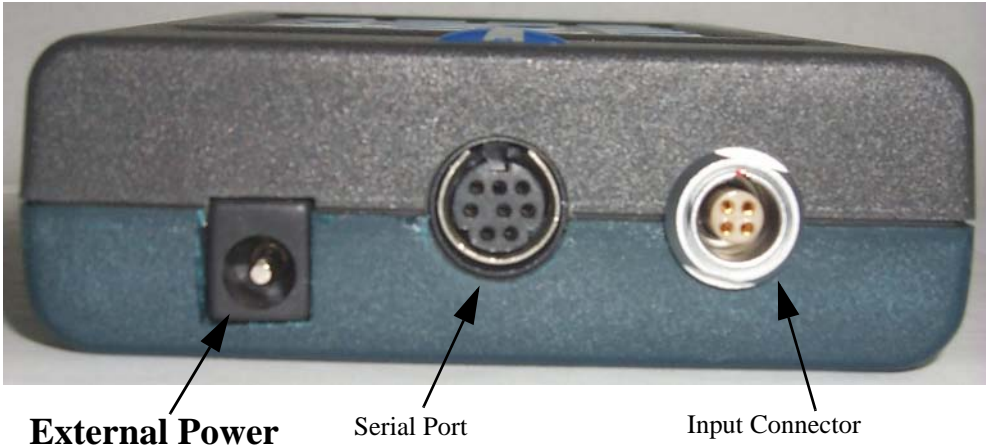

The power supply normally used with the HVM100 is the Larson Davis PSA027. This is a switching power supply that will operate on 90 to 260 Volts AC, returning 12 Volts DC.

The connector pinout is as follows:

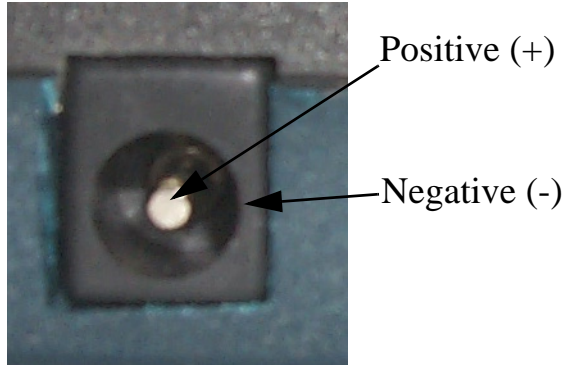
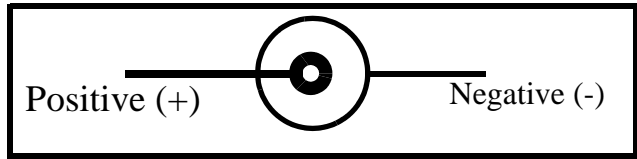

Connections on the HVM100

There are 4 connectors located on the outside case of the HVM100. The Serial Port, input connector, external power connector, and AD/DC Output connector.

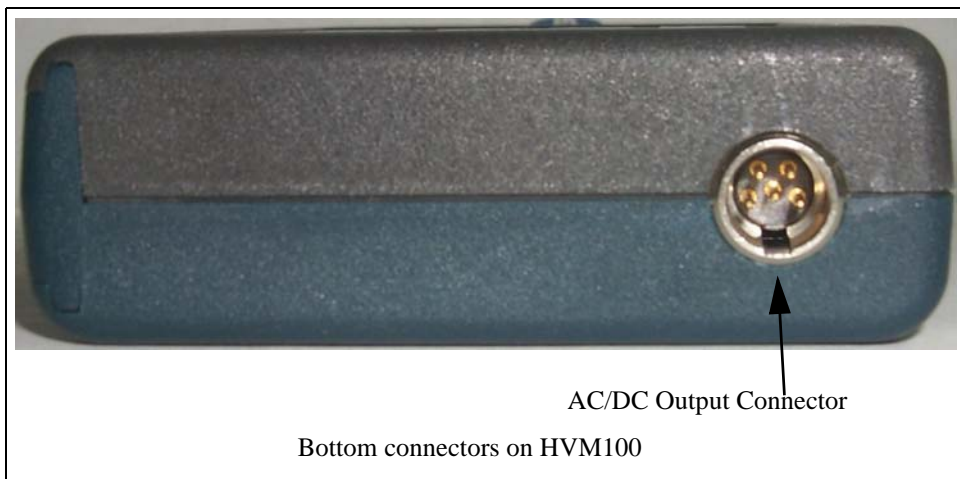
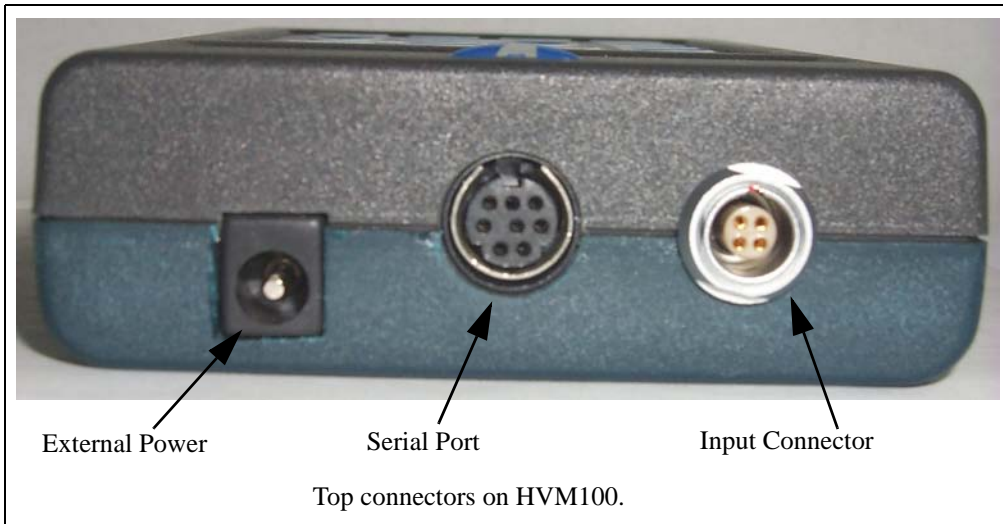

Serial Interface Port

The serial port is used for communicating with the HVM100. The serial port also provides the printer connection.

Pinout

The pinout is as follows,



Pin Number	Description
1 - RTS	Request To Send
2 - CTS	Clear To Send
3 - TXD	Transmit Data
4 - Ground	Signal Ground
5 - RXD	Receive Data
6 - Ground	Signal Ground
7 - N/C	No Connection

Pin Number	Description
8 - N/C	No Connection
The shell of the connector is connected to the Case Shield Ground	

Cables Used

The standard cable used with the HVM100, is the CBL006. This is a serial connection cable and can be used when communicating through software or printing to a Hyperterminal connection.

Transducer Connection

The transducer connection is the input connection into the HVM100. It is located on the top of the HVM100 case. The connector used is a standard 4-pin LEMO® connector.

Pinout

The pinout is as follows,



Pin #	Description
1	Z - Axis input
2	Y - Axis input
3	X - Axis input
4	Ground

External Power Connection

The HVM100 can also operate on 7 to 30 Volts DC external power. The external power connector is on the top of the HVM100.

Pinout

The connector pinout is as follows:

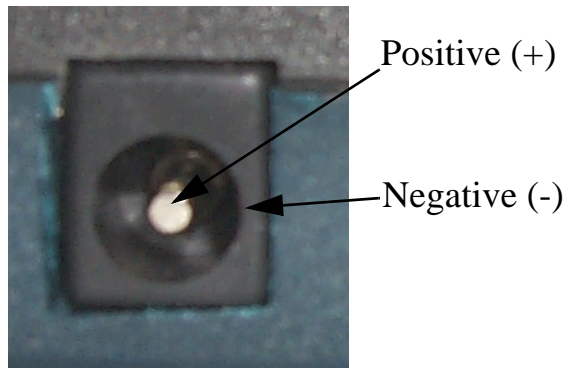
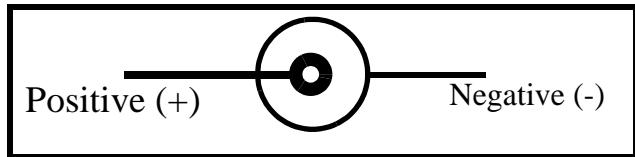

Larson Davis Adapter

The power supply normally used with the HVM100 is the Larson Davis PSA027. This is a switching power supply that will operate on 90 to 260 Volts AC, returning 12 Volts DC.

AC/DC Output Connector

AC output is useful for frequency analysis by an external analyzer or for recording in a tape recorder. The DC output is useful for a chart recorder, or to measure the voltage proportional to the RMS or peak value.

The DC output is updated according to the averaging time. If the averaging time is set to slow, the signal on the DC output pin for the selected channel will be updated once per second. If the averaging time is set to 60 seconds, the signal on the DC output pin for the selected channel will be updated once every 60 seconds.

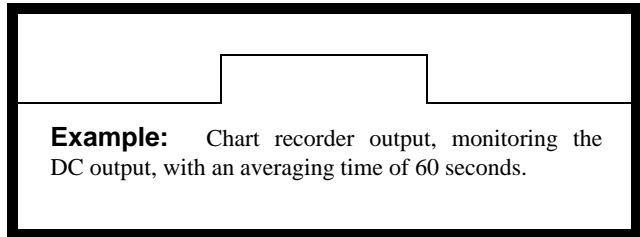

The AC output will produce a signal from 0 - 0.5 Volt RMS.

The scale of the DC output is typically 5 mV/dB. The level typically varies between 0 Vdc to +1.0 Vdc.

Pinout

The AC/DC output connector is a 5 pin Switchcraft® connector located on the bottom edge of the instrument. The pinout is as follows:



Pin #	Description
1	Ground
2	X - Axis AC/DC Output
3	Y - Axis AC/DC Output
4	No Connection
5	Z - Axis AC/DC Output

The signal that is output on each pin is selectable for each channel. The selections are the same for each channel. We will list the X channel selections, however the available selections will be the same for all operating modes as well.

Adaptor Resonances

In this chapter are presented frequency response function data for adaptors ADP080A, ADP081A and ADP082A as required by ISO 8041:2005

Conclusion

Experimental measurements indicate no resonances within the Wh frequency range for the adaptors ADP080A, ADP081A and ADP082A.

Mechanical

Specification	Unit	ADP080A	ADP081A	ADP082A
Total Mass of Vibration Sensor & Mounting System(including sensor, adapter, & mounting screw)	ounces (grams)	0.67 (19)	0.74 (21)	0.35 (10)
Mounting Height of Vibration Sensor (distance between sensor and mounting surface)	inches (mm)	0.32 (8.0)	0.18 (4.6)	0.32 (8.1)
Adapter dimensions	inches (mm)	Shown Below	Shown Below	Shown Below

ADP080A
(Hand Adapter with SEN04XF
Accelerometer)

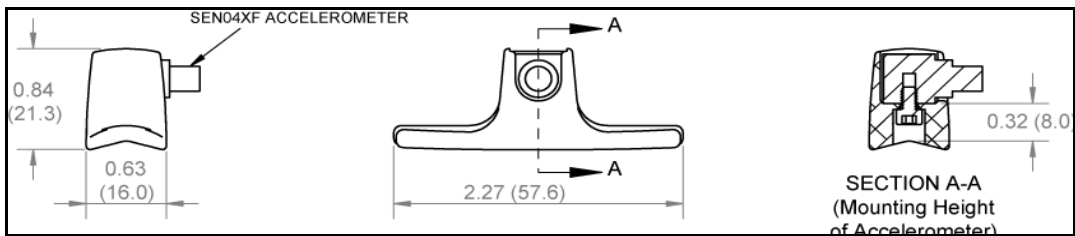

ADP081A
(Handle Adapter with SEN04XF
Accelerometer)

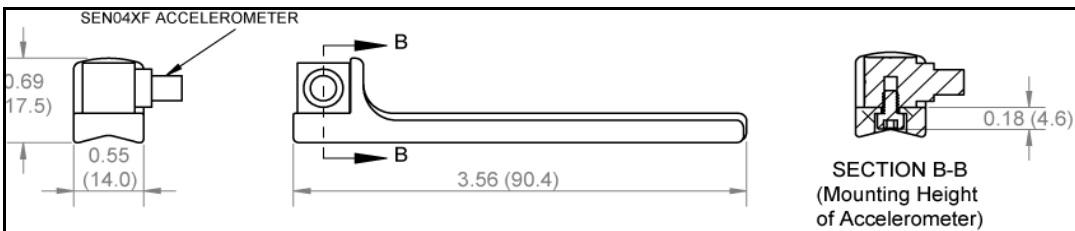

ADP082A
(Clamp Adapter with SEN04XF
Accelerometer)

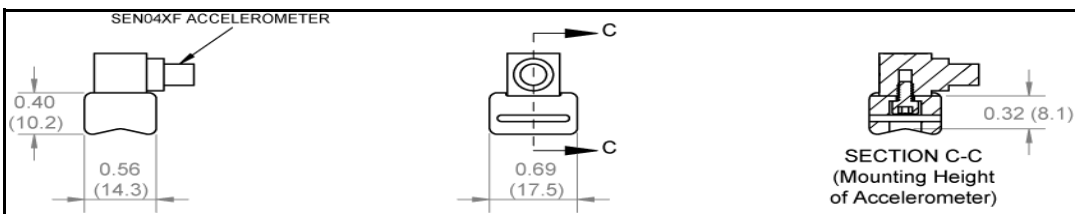

Measurements

Frequency Response

The frequency response measurements were performed by suspending the test object and exciting it with a modal hammer. The responses were measured in x, y and z directions using a triaxial accelerometer connected to the test object using the specified adapter. A graphic is included to illustrate the test configuration.

Triaxial Accelerometer

The triaxial accelerometer used for these tests was a Larson Davis Model SEN041F having a sensitivity of 10 mV/g.

ADP080A + SEN041

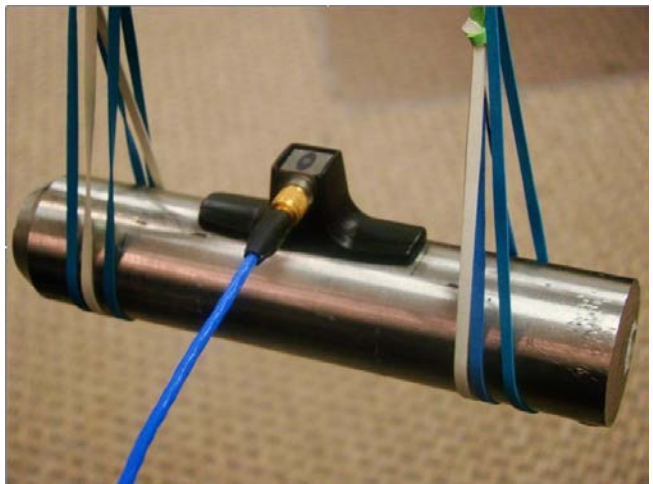

Frequency Response Function X, Y and Z

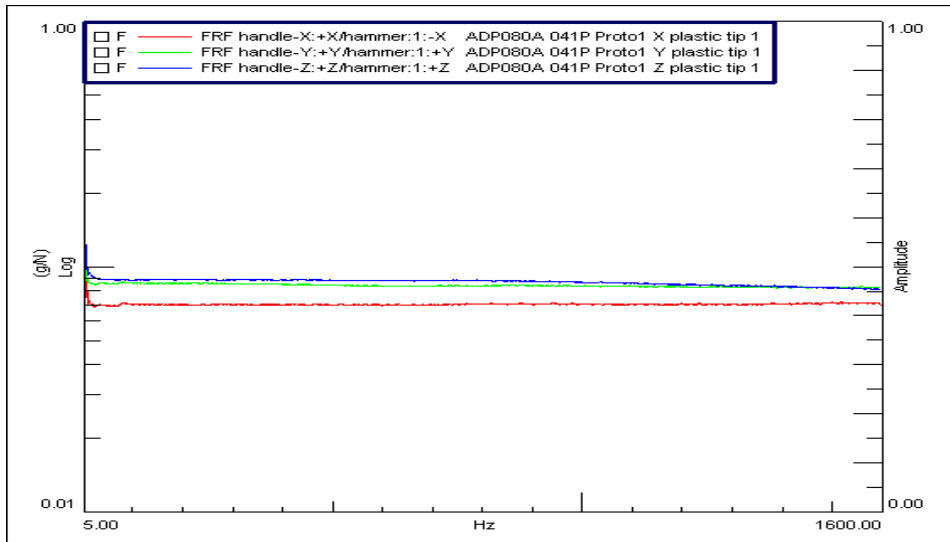

ADP081A + SEN041

Frequency Response Function X, Y and Z

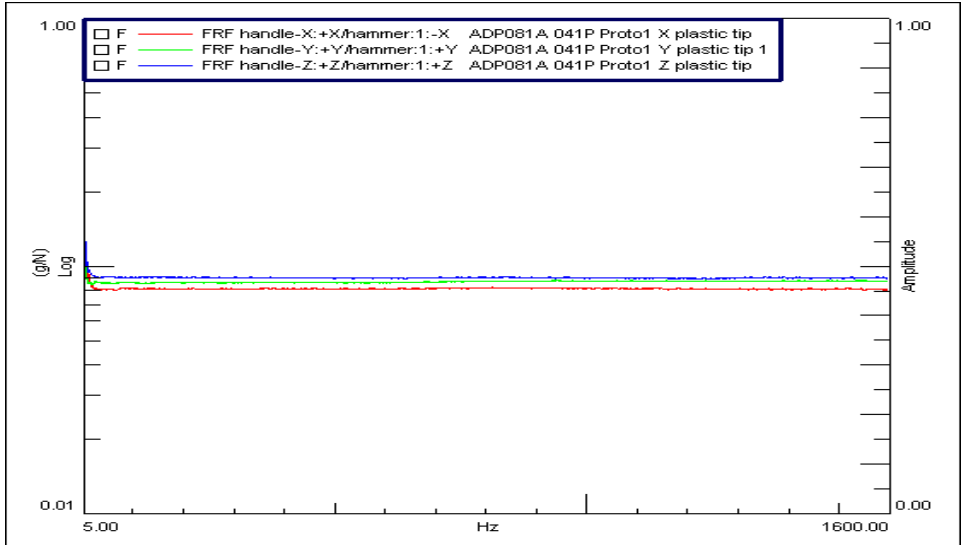

ADP082A + SEN041

Frequency Response Function X, Y and Z

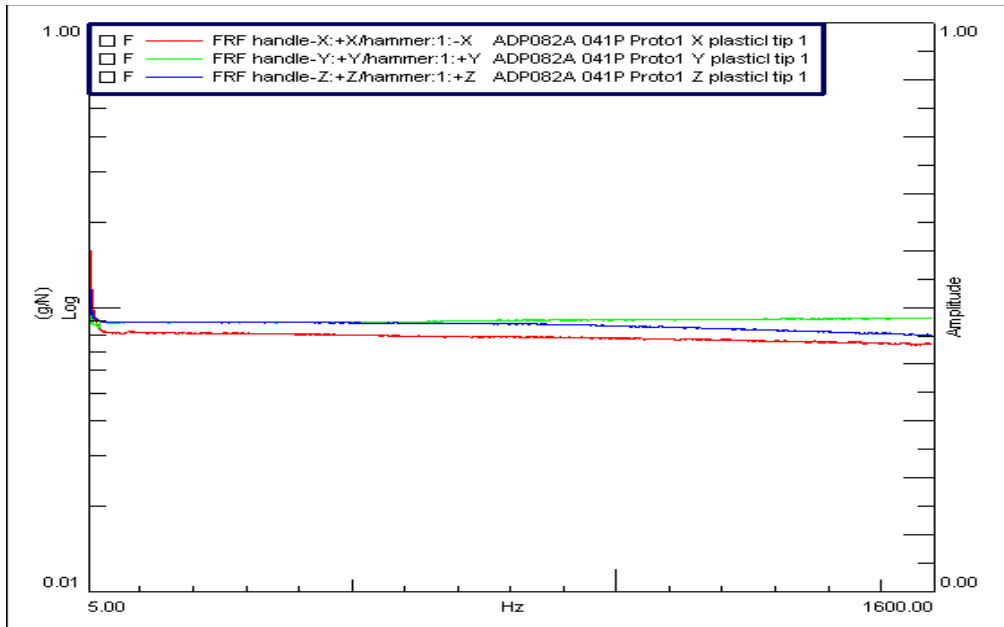

A

Specifications

Specifications are subject to change without notice. Numerical values given are typical. Refer to specific calibration or test results for accurate data on a specific unit.

General Characteristics

Type Precision

The Larson Davis HVM100 Human Vibration Meter is a Type 1 instrument designed for use in assessing vibration as perceived by human beings. The instrument meets the requirements of ISO 8041:2005(E).

Additionally, the current ISO 8041:2005 standard, and therefore the HVM100, is compatible with the standards listed below. These standards define methods for the measurement of whole-body and hand-arm vibration.

ISO 2631-1:1997 Mechanical vibration and shock --
Evaluation of human exposure to whole-body vibration --
Part 1: General requirements

ISO 2631-2:2003 Evaluation of human exposure to whole-body vibration -- Part 2: Continuous and shock-induced vibrations in buildings (1 to 80 Hz)

ISO 2631-4:2001 Mechanical vibration and shock --
Evaluation of human exposure to whole-body vibration --
Part 4: Guidelines for the evaluation of the effects of
vibration and rotational motion on passenger and crew

comfort in fixed-guideway transport systems

ISO 5349-1:2001 Mechanical vibration -- Measurement and evaluation of human exposure to hand-transmitted vibration -- Part 1: General requirements

ISO 5349-2:2001 Mechanical vibration -- Measurement and evaluation of human exposure to hand-transmitted vibration -- Part 2: Practical guidance for measurement at the workplace

Effects of Temperature

The RMS level varies ± 0.5 dB when the complete instrument is tested over the -10°C to 50°C temperature range. The reference reading, for this test, is taken at 20°C and 36% relative humidity (RH); the input signal is at 79.6 Hz.

Effects of Humidity

The RMS level varies ± 0.5 dB when the complete instrument is tested over the 30% to 90% RH range. This test is performed at 40°C , with an input signal of 79.6 Hz.

Limits of Temperature and Humidity

Permanent damage can occur when stored or operated above 60°C or below -20°C . Condensation of moisture will make readings inaccurate. When condensation dissipates, readings should return to normal.

Effects of Magnetic Fields

The RMS level varies ± 0.5 dB when the complete instrument is tested in an 80 A/m, 60 Hz magnetic field (worst case orientation).

Effects of Mechanical Vibrations

The instrument meets the specifications for susceptibility to vibration in accordance with ISO 8041:2005(E) section 7.1.

Stabilization Time

At power-on, allow the instrument to stabilize, approximately 20 seconds, prior to performing any measurements. When changing from one type of input (Direct/Charge/ICP[®]) to another or when changing the instruments gain settings, allow 10 seconds of stabilization time prior to performing a new measurement.

Data Storage

- 1/2 Mega Byte Memory

- Capable of storing 100 files and 10 setups
- 2 minute (typical) data retention for clock during battery change

Data Communications

- RS-232 Serial Interface
- Maximum Data Rate: 115,000 bits per second

Digital Display

- 2 line, 32 digit, 7 segment LCD display
- Full ASCII character set
- 0.1 dB resolution

Real-time Clock/Calendar

- Accuracy: 0.02% (-10° C to 50° C)
- 24 hour clock: hh:mm

Run-time Clock

- One second resolution
- Format: hh:mm:ss
- Maximum run time: 99:59:59

Power Supply

- 2 AA (1.5V) alkaline batteries
- Typically operates for 12 hours (Charge/Direct modes)
- Battery life is reduced to approximately 4 hours when using ICP® accelerometers.
- External Power: 7-30 volts DC

Dimensions/Weight

- Width: 3.25 inches (8.3 cm)
- Length: 6.0 inches (15.2 cm)
- Depth: 1.0 inches (2.5 cm)
- Weight: 9.8 ounces (279 grams) - including batteries

Declaration of Conformity



PCB Piezotronics Inc. declares that:

- Product Name: Human Vibration Meter
- Model: HVM100

The Model HVM100 Human Vibration Meter complies with the European Community EMC Directive (2004/108/EC) and also with the Low Voltage Safety Directive (2006/95/EC) by meeting the following standards:

- IEC 61326-1:2005-Electrical equipment for measurement, control and laboratory use-EMC requirements-Part 1: General requirements.
 - IEC 61000-4-2:2008-Electrostatic discharge immunity test $\pm 4\text{kV}$ contact ESD and $\pm 8\text{kV}$ air ESD). Performance Criteria B.
 - IEC61000-4-3:2006 with am1 2007-Radiated, radio-frequency electromagnetic field immunity test. 26 to 1,000 MHz at 10 V/m, 1.4 to 2.0 GHz at 3 V/M, and 2.0 to 2.7 GHz at 1 V/M, all with AM 80%, 1 kHz. $\Delta < \pm 6\%$ from 1 g. Performance Criteria A.
 - IEC61000-4-8:2009: Power frequency magnetic field immunity test. 80 A/m, 50/60 Hz. $\Delta < 3\%$ from 1 g. Performance Criteria A.
 - CISPR 11:2009-Industrial, scientific and medical equipment-Radio-frequency disturbance characteristics-Limits and methods of measurement. Class B, Group 1.
- IEC 61010-1:2001- Safety requirements for electrical equipment for measurement, control, and laboratory use-Part 1:General requirements.

This device complies with Part 15 of the FCC Rules. Operation is subject to the following two conditions:

- (1) This device may not cause harmful interference

(2) This device must accept any interference received, including interference that may cause undesired operation.

Outputs

The output impedance is 475 ohms for all of the Analog AC and Analog DC outputs. For minimal error, use instrument with a greater than 100,000 ohm input impedance when making AC or DC output measurements.

Transducer Electrical Impedance

During electrical testing, the following circuits were used in place of the transducer.

Direct Input

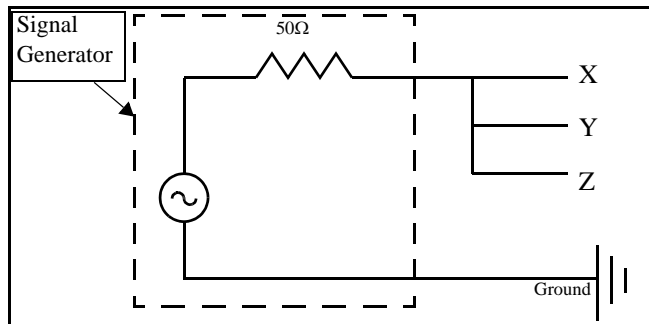

ICP® Input

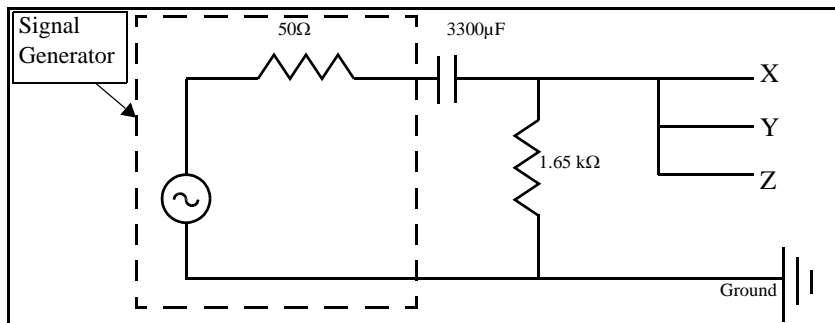

Charge Input

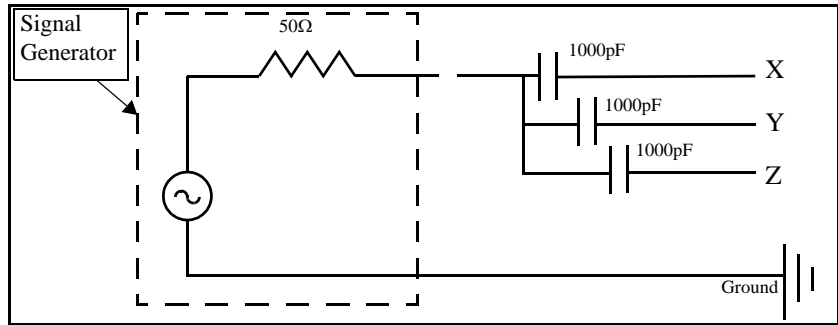

Functions Measured

Mode	Data Buffer Measurements	Time History Buffer Measurements
Vibration	Arms, Amin, Amax, Amp, Peak, Aeq, PE	Arms with optional Peak
Hand Arm	Arms, Amin, Amax, Amp, Peak, Aeq, A(1), A(2), A(4), A(8), A(8) Exposure, PE	Arms with optional Peak
Whole Body	Arms, Amin, Amax, Amp, Peak, Aeq, CFmp, CF, VDV, PE	Arms with optional Peak

Reference Acceleration

The reference acceleration (for displaying data in dB) is 10^{-6} m/s². the user can also select a reference of 10^{-5} m/s² (see section 4-3 of the manual for an explanation of how to select the reference acceleration.)

Reference Calibration Frequency

Operating Mode	Frequency Weighting	Reference Calibration Frequency
Vibration	Fa (0.4 Hz to 100 Hz)	7.96 Hz
	Ws (Severity) Fb (0.4 Hz to 1250 Hz) Fc (6.3 Hz to 1250 Hz)	79.6 Hz
Hand Arm	Wh	79.6 Hz
Whole Body	Wm Wb Wc Wd We Wg Wj Wk	7.96 Hz

Reference Calibration Vibration

The reference calibration vibration is 1 m/s^2

Frequency Weighting Curves

Fa (Flat 0.4 Hz to 100 Hz)

Freq (Hz) Nominal	Freq (Hz) True	Fa dB	Tolerance dB
0.100	0.1000	-24.10	+2/-∞
0.125	0.1259	-20.12	+2/ -∞
0.160	0.1585	-16.19	+2/ -∞
0.200	0.1995	-12.34	+2/ -∞
0.250	0.2512	-8.71	+2/-2
0.315	0.3162	-5.51	+2/-2
0.400	0.3981	-3.05	+1/-1
0.500	0.5012	-1.48	+1/-1
0.630	0.6310	-0.65	+1/-1
0.800	0.7943	-0.27	+1/-1
1.00	1.000	-0.11	+1/-1
1.25	1.259	-0.04	+1/-1
1.60	1.585	-0.02	+1/-1
2.00	1.995	-0.01	+1/-1
2.50	2.512	0.00	+1/-1
3.15	3.162	0.00	+1/-1
4.00	3.981	0.00	+1/-1
5.00	5.012	0.00	+1/-1
6.30	6.310	0.00	+1/-1
8.00	7.943	0.00	0
10.0	10.00	0.00	+1/-1
12.5	12.59	0.00	+1/-1

Freq (Hz) Nominal	Freq (Hz) True	Fa dB	Tolerance dB
16.0	15.85	0.00	+1/-1
20.0	19.95	-0.01	+1/-1
25.0	25.12	-0.02	+1/-1
31.5	31.62	-0.04	+1/-1
40.0	39.81	-0.11	+1/-1
50.0	50.12	-0.27	+1/-1
63.0	63.10	-0.64	+1/-1
80.0	79.43	-1.46	+1/-1
100	100.0	-3.01	+1/-1
125	125.9	-5.46	+2/-2
160	158.5	-8.64	+2/-2
200	199.5	-12.27	+2/ -∞
250	251.2	-16.11	+2/ -∞
315	316.2	-20.04	+2/ -∞
400	398.1	-24.02	+2/ -∞

**Fb (Flat 0.4 Hz to 1260 Hz)
Frequency Weighting**

Freq (Hz) Nominal	Freq (Hz) True	Fb dB	Tolerance dB
0.100	0.1000	-24.10	+2 / -∞
0.125	0.1259	-20.12	+2 / -∞
0.160	0.1585	-16.19	+2 / -∞
0.200	0.1995	-12.34	+2 / -∞
0.250	0.2512	-8.71	+2 / -2
0.315	0.3162	-5.51	+1 / -1

Freq (Hz) Nominal	Freq (Hz) True	Fb dB	Tolerance dB
0.400	0.3981	-3.05	+1 / -1
0.500	0.5012	-1.48	+1 / -1
0.630	0.6310	-0.65	+1 / -1
0.800	0.7943	-0.27	+1 / -1
1.00	1.000	-0.11	+1 / -1
1.25	1.259	-0.04	+1 / -1
1.60	1.585	-0.02	+1 / -1
2.00	1.995	-0.01	+1 / -1
2.50	2.512	0.00	+1 / -1
3.15	3.162	0.00	+1 / -1
4.00	3.981	0.00	+1 / -1
5.00	5.012	0.00	+1 / -1
6.30	6.310	0.00	+1 / -1
8.00	7.943	0.00	+1 / -1
10.0	10.00	0.00	+1 / -1
12.5	12.59	0.00	+1 / -1
16.0	15.85	0.00	+1 / -1
20.0	19.95	0.00	+1 / -1
25.0	25.12	0.00	+1 / -1
31.5	31.62	0.00	+1 / -1
40.0	39.81	0.00	+1 / -1
50.0	50.12	0.00	+1 / -1
63.0	63.10	0.00	+1 / -1
80.0	79.43	0.00	0
100	100.0	0.00	+1 / -1

Freq (Hz) Nominal	Freq (Hz) True	Fb dB	Tolerance dB
125	125.9	0.00	+1 / -1
160	158.5	0.00	+1 / -1
200	199.5	0.00	+1 / -1
250	251.2	-0.01	+1 / -1
315	316.2	-0.02	+1 / -1
400	398.1	-0.04	+1 / -1
500	501.2	-0.11	+1 / -1
630	631.0	-0.27	+1 / -1
800	794.3	-0.64	+1 / -1
1000	1000	-1.46	+2 / -2
1250	1259	-3.01	+2 / -2
1600	1585	-5.46	+2 / -2
2000	1995	-8.64	+2 / -2
2500	2512	-12.27	+2 / -∞
3150	3162	-16.11	+2 / -∞
4000	3981	-20.04	+2 / -∞
5000	5012	-24.02	+2 / -∞
6300	6310	-28.01	+2 / -∞
8000	7943	-32.00	+2 / -∞
10000	10000	-36.00	+2 / -∞

**Fc (Flat 6.3 Hz to 1260 Hz), Wh,
and Ws Frequency Weighting.**

Freq (Hz) Nominal	Freq (Hz) True	Fc dB	Wh dB	Tolerance dB	Ws dB	Tolerance dB
0.800	0.7943	-36.00	-36.00	+2 / -∞	-76.00	+4 / -∞
1.00	1.000	-32.00	-31.99	+2 / -∞	-68.00	+4 / -∞
1.25	1.259	-28.01	-27.99	+2 / -∞	-60.00	+4 / -∞
1.60	1.585	-24.02	-23.99	+2 / -∞	-52.00	+4 / -∞
2.00	1.995	-20.04	-20.01	+2 / -∞	-44.00	+4 / -∞
2.50	2.512	-16.11	-16.05	+2 / -∞	-36.00	+4 / -4
3.15	3.162	-12.27	-12.18	+2 / -∞	-28.00	+4 / -4
4.00	3.981	-8.64	-8.51	+2 / -2	-19.90	+4 / -4
5.00	5.012	-5.46	-5.27	+2 / -2	-12.20	+4 / -4
6.30	6.310	-3.01	-2.77	+2 / -2	-5.30	+4 / -4
8.00	7.943	-1.46	-1.18	+2 / -2	-1.50	+4 / -4
10.0	10.00	-0.64	-0.43	+1 / -1	0.00	+1 / -2
12.5	12.59	-.027	-0.38	+1 / -1	0.00	+1 / -2
16.0	15.85	-0.11	-0.96	+1 / -1	0.00	+1 / -2
20.0	19.95	-0.04	-2.14	+1 / -1	0.00	+1 / -1
25.0	25.12	-0.02	-3.78	+1 / -1	0.00	+1 / -1
31.5	31.62	-0.01	-5.69	+1 / -1	0.00	+1 / -1
40.0	39.81	0.00	-7.72	+1 / -1	0.00	+1 / -1
50.0	50.12	0.00	-9.78	+1 / -1	0.00	+1 / -1
63.0	63.10	0.00	-11.83	+1 / -1	0.00	+1 / -1
80.0	79.43	0.00	-13.88	0	0.00	0
100	100.0	0.00	-15.91	+1 / -1	0.00	+1 / -1
125	125.9	0.00	-17.93	+1 / -1	0.00	+1 / -1

Freq (Hz) Nominal	Freq (Hz) True	Fc dB	Wh dB	Tolerance dB	Ws dB	Tolerance dB
160	158.5	0.00	-19.94	+1 / -1	0.00	+1 / -1
200	199.5	0.00	-21.95	+1 / -1	0.00	+1 / -1
250	251.2	-0.01	-23.96	+1 / -1	0.00	+1 / -1
315	316.2	-0.02	-25.98	+1 / -1	0.00	+1 / -1
400	398.1	-0.04	-28.00	+1 / -1	0.00	+1 / -1
500	501.2	-0.11	-30.07	+1 / -1	0.00	+1 / -1
630	631.0	-0.27	-32.23	+1 / -1	0.00	+1 / -2
800	794.3	-0.64	-34.60	+1 / -1	0.00	+1 / -2
1000	1000	-1.46	-37.42	+2 / -2	0.00	+1 / -2
1250	1259	-3.01	-40.97	+2 / -2	-1.70	+4 / -4
1600	1585	-5.46	-45.42	+2 / -2	-4.30	+4 / -4
2000	1995	-8.64	-50.60	+2 / -2	-9.80	+4 / -4
2500	2512	-12.27	-56.23	+2 / -∞	-16.30	+4 / -4
3150	3162	-16.11	-62.07	+2 / -∞	-25.80	+4 / -4
4000	3981	-20.04	-68.01	+2 / -∞	-36.00	+4 / -4
5000	5012	-24.02	-73.98	+2 / -∞	-44.00	+4 / -∞
6300	6310	-28.01	-79.97	+2 / -∞	-52.00	+4 / -∞
8000	7943	-32.00	-85.97	+2 / -∞	-60.00	+4 / -∞
10000	10000	-36.00	-91.97	+2 / -∞	-68.00	+4 / -∞

Wm, Wc, and Wd Frequency Weightings

Freq (Hz) Nominal	Freq (Hz) True	Wm dB	Wc dB	Wd dB	Tolerance dB
0.100	0.100	-32.04	-24.10	-24.09	+2 / -∞
0.125	0.1259	-28.20	-20.12	-20.12	+2 / -∞

Freq (Hz) Nominal	Freq (Hz) True	Wm dB	Wc dB	Wd dB	Tolerance dB
0.160	0.1585	-23.98	-16.19	-16.18	+2 / -∞
0.200	0.1995	-20.23	-12.34	-12.32	+2 / -∞
0.250	0.2512	-16.71	-8.71	-8.68	+2 / -2
0.315	0.3162	-13.51	-5.51	-5.47	+2 / -2
0.400	0.3981	-10.98	-3.05	-2.98	+1 / -1
0.500	0.5012	-9.53	-1.47	-1.37	+1 / -1
0.630	0.6310	-8.71	-0.64	-0.50	+1 / -1
0.800	0.7943	-8.38	-0.25	-0.08	+1 / -1
1.00	1.00	-8.29	-0.08	+0.10	+1 / -1
1.25	1.259	-8.27	+0.00	+0.06	+1 / -1
1.60	1.585	-8.07	+0.06	-0.26	+1 / -1
2.00	1.995	-7.60	+0.10	-1.00	+1 / -1
2.50	2.512	-6.13	+0.15	-2.23	+1 / -1
3.15	3.162	-3.58	+0.19	-3.88	+1 / -1
4.00	3.981	-1.02	+0.21	-5.78	+1 / -1
5.00	5.012	0.21	+0.11	-7.78	+1 / -1
6.30	6.310	0.46	-0.23	-9.83	+1 / -1
8.00	7.943	0.21	-0.97	-11.87	0
10.0	10.0	-0.23	-2.20	-13.91	+1 / -1
12.5	12.59	-0.85	-3.84	-15.93	+1 / -1
16.0	15.85	-1.83	-5.74	-17.95	+1 / -1
20.0	19.95	-3.00	-7.75	-19.97	+1 / -1
25.0	25.12	-4.44	-9.80	-21.98	+1 / -1
31.5	31.62	-6.16	-11.87	-24.01	+1 / -1
40.0	39.81	-8.11	-13.97	-26.08	+1 / -1

Freq (Hz) Nominal	Freq (Hz) True	Wm dB	Wc dB	Wd dB	Tolerance dB
50.0	50.12	-10.09	-16.15	-28.24	+1 / -1
63.0	63.10	-12.43	-18.55	-30.62	+1 / -1
80.0	79.43	-15.34	-21.37	-33.43	+1 / -1
100	100.0	-18.72	-24.94	-36.99	+1 / -1
125	125.9	-23.00	-29.39	-41.43	+2 / -2
160	158.5	-28.56	-34.57	-46.62	+2 / -2
200	199.5	-34.03	-40.20	-52.24	+2 / -∞
250	251.2	-39.69	-46.04	-58.09	+2 / -∞
315	316.2	-45.65	-51.98	-64.02	+2 / -∞
400	398.1	-51.84	-57.95	-70.00	+2 / -∞

We, Wj, and Wk Frequency Weighting

Freq (Hz) Nominal	Freq (Hz) True	We dB	Wj dB	Wk dB	Tolerance dB
0.100	0.100	-24.08	-30.18	-30.11	+2 / -∞
0.125	0.1259	-20.09	-26.20	-26.14	+2 / -∞
0.160	0.1585	-16.14	-22.27	-22.21	+2 / -∞
0.200	0.1995	-12.27	-18.42	-18.37	+2 / -∞
0.250	0.2512	-8.60	-14.79	-14.74	+2 / -2
0.315	0.3162	-5.36	-11.60	-11.55	+2 / -2
0.400	0.3981	-2.86	-9.15	-9.11	+1 / -1
0.500	0.5012	-1.27	-7.58	-7.56	+1 / -1
0.630	0.6310	-0.55	-6.77	-6.77	+1 / -1
0.800	0.7943	-0.52	-6.42	-6.44	+1 / -1
1.00	1.00	-1.11	-6.30	-6.33	+1 / -1
1.25	1.259	-2.29	-6.28	-6.29	+1 / -1

Freq (Hz) Nominal	Freq (Hz) True	We dB	Wj dB	Wk dB	Tolerance dB
1.60	1.585	-3.91	-6.32	-6.13	+1 / -1
2.00	1.995	-5.80	-6.34	-5.50	+1 / -1
2.50	2.512	-7.81	-6.22	-3.97	+1 / -1
3.15	3.162	-9.85	-5.60	-1.86	+1 / -1
4.00	3.981	-11.89	-4.08	-0.31	+1 / -1
5.00	5.012	-13.93	-1.99	+0.33	+1 / -1
6.30	6.310	-15.95	-0.47	+0.46	+1 / -1
8.00	7.943	-17.97	+0.14	+0.32	0
10.0	10.0	-19.98	+0.26	-0.10	+1 / -1
12.5	12.59	-21.99	+0.22	-0.93	+1 / -1
16.0	15.85	-23.99	+0.16	-2.22	+1 / -1
20.0	19.95	-26.00	+0.10	-3.91	+1 / -1
25.0	25.12	-28.01	+0.06	-5.84	+1 / -1
31.5	31.62	-30.04	+0.00	-7.89	+1 / -1
40.0	39.81	-32.11	-0.08	-10.01	+1 / -1
50.0	50.12	-34.26	-0.25	-12.21	+1 / -1
63.0	63.10	-36.64	-0.63	-14.62	+1 / -1
80.0	79.43	-39.46	-1.45	-17.47	+1 / -1
100	100.0	-43.01	-3.01	-21.04	+1 / -1
125	125.9	-47.46	-5.45	-25.50	+2 / -2
160	158.5	-52.64	-8.64	-30.69	+2 / -2
200	199.5	-58.27	-12.26	-36.32	+2 / -∞
250	251.2	-64.11	-16.11	-42.16	+2 / -∞
315	316.2	-70.04	-20.04	-48.10	+2 / -∞
400	398.1	-76.02	-24.02	-54.08	+2 / -∞

**Wg Frequency Weighting
(Defined in BS6841:1987)**

Freq (Hz) Nominal	Freq (Hz) True	Wg dB	Tolerance dB
1.00	1.00	-7.5	+1 / -1
1.25	1.26	-6.0	+1 / -1
1.60	1.59	-4.6	+1 / -1
2.00	2.00	-3.4	+1 / -1
2.50	2.51	-2.2	+1 / -1
3.15	3.16	-0.9	+1 / -1
4.00	3.98	-0.0	+1 / -1
5.00	5.01	+0.4	+1 / -1
6.30	6.31	+0.1	+1 / -1
8.00	7.94	-1.0	0
10.0	10.00	-2.5	+1 / -1
12.5	12.59	-4.2	+1 / -1
16.0	15.85	-6.3	+1 / -1
20.0	19.95	-8.2	+1 / -1
25.0	25.12	-10.1	+1 / -1
31.5	31.62	-12.1	+1 / -1
40.0	39.81	-14.2	+1 / -1
50.0	50.12	-16.3	+1 / -1
63.0	63.10	-18.7	+1 / -1
80.0	79.43	-21.6	+1 / -1

Wm (Whole Body) Frequency Weighting

Freq (Hz) Nominal	Freq (Hz) True	WM dB	Tolerance dB
0.100	0.100	-36.00	+2 / -∞
0.125	0.1259	-32.00	+2 / -∞
0.160	0.1585	-28.01	+2 / -∞
0.200	0.1995	-24.02	+2 / -∞
0.250	0.2512	-20.05	+2 / -∞
0.315	0.3162	-16.12	+2 / -∞
0.400	0.3981	-12.29	+2 / -∞
0.500	0.5012	-8.67	+2 / -2
0.630	0.6310	-5.51	+2 / -2
0.800	0.7943	-3.09	+2 / -2
1.00	1.00	-1.59	+2 / -2
1.25	1.259	-0.85	+1 / -1
1.60	1.585	-0.59	+1 / -1
2.00	1.995	-0.61	+1 / -1
2.50	2.512	-0.82	+1 / -1
3.15	3.162	-1.19	+1 / -1
4.00	3.981	-1.74	+1 / -1
5.00	5.012	-2.50	+1 / -1
6.30	6.310	-3.49	+1 / -1
8.00	7.943	-4.70	0
10.0	10.0	-6.12	+1 / -1
12.5	12.59	-7.71	+1 / -1
16.0	15.85	-9.44	+1 / -1

Freq (Hz) Nominal	Freq (Hz) True	WM dB	Tolerance dB
20.0	19.95	-11.25	+1 / -1
25.0	25.12	-13.14	+1 / -1
31.5	31.62	-15.09	+1 / -1
40.0	39.81	-17.10	+1 / -1
50.0	50.12	-19.23	+1 / -1
63.0	63.10	-21.58	+1 / -1
80.0	79.43	-24.38	+2 / -2
100	100.0	-27.93	+2 / -2
125	125.9	-32.37	+2 / -2
160	158.5	-37.55	+2 / -2
200	199.5	-43.18	+2 / -∞
250	251.2	-49.02	+2 / -∞
315	316.2	-54.95	+2 / -∞
400	398.1	-60.92	+2 / -∞
500	501.2	-66.91	+2 / -∞
630	631.0	-72.91	+2 / -∞
800	794.3	-78.91	+2 / -∞

Typical Measurements Ranges

Vibration - Fa

Gain	Direct			Charge (1000pF)			ICP®		
	Noise Floor dB μ V	RMS Range dB μ V	Peak Range dB μ V	Noise Floor dB μ V	RMS Range dB μ V	Peak Range dB μ V	Noise Floor dB μ V	RMS Range dB μ V	Peak Range dB μ V
0 dB	See Note 1	60 dB 74-134	38 dB 99-137	See Note 1	60 dB 74-134	38 dB 99-137	See Note 1	60 dB 74-134	38 dB 99-137
20 dB	See Note 1	60 dB 54-114	38 dB 79-117	See Note 1	60 dB 54-114	38 dB 79-117	See Note 1	60 dB 54-114	38 dB 79-17
40 dB	26	58 dB 36-94	36 dB 61-97	26	58 dB 36-94	36 dB 61-97	26	58 dB 36-94	36 dB 61-97
60 dB	17	47 dB 27-74	25 dB 52-77	17	47 dB 27-74	25 dB 52-77	23	41 dB 33-74	19 dB 58-77

Notes:

1. Under-Range (?) - The noise floor is below the measurement range of the analog to digital converter.
2. The data in the above table was obtained by electrically testing the HVM100.

Vibration - Fb, Fc, Ws

Gain	Direct			Charge (1000pF)			ICP®		
	Noise Floor dB μ V	RMS Range dB μ V	Peak Range dB μ V	Noise Floor dB μ V	RMS Range dB μ V	Peak Range dB μ V	Noise Floor dB μ V	RMS Range dB μ V	Peak Range dB μ V
0 dB	64	60 dB 74-134	38 dB 99-137	64	60 dB 74-134	38 dB 99-137	64	60 dB 74-134	38 dB 99-137
20 dB	44	60 dB 54-114	38 dB 79-117	44	60 dB 54-114	38 dB 79-117	44	60 dB 54-114	38 dB 79-117
40 dB	30	54 dB 40-94	32 dB 65-97	30	54 dB 40-94	32 dB 65-97	30	54 dB 40-94	32 dB 65-97
60 dB	23	41 dB 33-74	19 dB 58-77	23	41 dB 33-74	19 dB 58-77	23	41 dB 33-74	19 dB 58-77

Notes

1. The data in the above table was obtained by electrically testing the HVM100.

Hand Arm - Wh

Gain	Direct			Charge (1000pF)			ICP®		
	Noise Floor dB μ V	RMS Range dB μ V	Peak Range dB μ V	Noise Floor dB μ V	RMS Range dB μ V	Peak Range dB μ V	Noise Floor dB μ V	RMS Range dB μ V	Peak Range dB μ V
0 dB	See Note 1	60 dB 74-134	38 dB 99-137	See Note 1	60 dB 74-134	38 dB 99-137	See Note 1	60 dB 74-134	38 dB 99-137
20 dB	See Note 1	60 dB 54-114	38 dB 79-117	See Note 1	60 dB 54-114	38 dB 79-117	See Note 1	60 dB 54-114	38 dB 79-117
40 dB	See Note 1	60 dB 34-94	38 dB 59-97	See Note 1	60 dB 34-94	38 dB 59-97	See Note 1	60 dB 34-94	38 dB 59-97
60 dB	10	54 dB 20-74	32 dB 45-77	10	54 dB 20-74	32 dB 45-77	10	54 dB 20-74	32 dB 45-77

Notes:

1. Under-Range (?) - The noise floor is below the measurement range of the analog to digital converter.
2. The data in the above table was obtained by electrically testing the HVM100.

Whole Body - Wm

Gain	Direct			Charge (1000pF)			ICP®		
	Noise Floor dB μ V	RMS Range dB μ V	Peak Range dB μ V	Noise Floor dB μ V	RMS Range dB μ V	Peak Range dB μ V	Noise Floor dB μ V	RMS Range dB μ V	Peak Range dB μ V
0 dB	See Note 1	60 dB 74-134	38 dB 99-137	See Note 1	60 dB 74-134	38 dB 99-137	See Note 1	60 dB 74-134	38 dB 99-137
20 dB	See Note 1	60 dB 54-114	38 dB 79-117	See Note 1	60 dB 54-114	38 dB 79-117	See Note 1	60 dB 54-114	38 dB 79-117
40 dB	See Note 1	60 dB 34-94	38 dB 59-97	See Note 1	60 dB 34-94	38 dB 59-97	See Note 1	60 dB 34-94	38 dB 59-97
60 dB	14	50 dB 24-74	28 dB 49-77	14	50 dB 24-74	28 dB 49-77	14	50 dB 24-74	28 dB 49-77

Notes:

1. Under-Range (?) - The noise floor is below the measurement range of the analog to digital converter.
2. The data in the above table was obtained by electrically testing the HVM100.

Whole Body - Wc

Gain	Direct			Charge (1000pF)			ICP®		
	Noise Floor dB μ V	RMS Range dB μ V	Peak Range dB μ V	Noise Floor dB μ V	RMS Range dB μ V	Peak Range dB μ V	Noise Floor dB μ V	RMS Range dB μ V	Peak Range dB μ V
0 dB	See Note 1	60 dB 74-134	38 dB 99-137	See Note 1	60 dB 74-134	38 dB 99-137	See Note 1	60 dB 74-134	38 dB 99-137
20 dB	See Note 1	60 dB 54-114	38 dB 79-117	See Note 1	60 dB 54-114	38 dB 79-117	See Note 1	60 dB 54-114	38 dB 79-117
40 dB	See Note 1	60 dB 34-94	38 dB 59-97	See Note 1	60 dB 34-94	38 dB 59-97	See Note 1	60 dB 34-94	38 dB 59-97
60 dB	13	51 dB 23-74	29 dB 48-77	13	51 dB 23-74	29 dB 48-77	23	41 dB 33-74	19 dB 58-77

Notes:

1. Under-Range (?) - The noise floor is below the measurement range of the analog to digital converter.
2. The data in the above table was obtained by electrically testing the HVM100.

Whole Body - Wd, We

Gain	Direct			Charge (1000pF)			ICP®		
	Noise Floor dB μ V	RMS Range dB μ V	Peak Range dB μ V	Noise Floor dB μ V	RMS Range dB μ V	Peak Range dB μ V	Noise Floor dB μ V	RMS Range dB μ V	Peak Range dB μ V
0 dB	See Note 1	60 dB 74-134	38 dB 99-137	See Note 1	60 dB 74-134	38 dB 99-137	See Note 1	60 dB 74-134	38 dB 99-137
20 dB	See Note 1	60 dB 54-114	38 dB 79-117	See Note 1	60 dB 54-114	38 dB 79-117	See Note 1	60 dB 54-114	38 dB 79-117
40 dB	See Note 1	60 dB 34-94	38 dB 59-97	See Note 1	60 dB 34-94	38 dB 59-97	See Note 1	60 dB 34-94	38 dB 59-97
60 dB	11	53 dB 21-74	31 dB 46-77	11	53 dB 21-74	31 dB 46-77	23	41 dB 33-74	19 dB 58-77

Notes:

1. Under-Range (?) - The noise floor is below the measurement range of the analog to digital converter.
2. The data in the above table was obtained by electrically testing the HVM100.

Whole Body - Wg

Gain	Direct			Charge (1000pF)			ICP®		
	Noise Floor dB μ V	RMS Range dB μ V	Peak Range dB μ V	Noise Floor dB μ V	RMS Range dB μ V	Peak Range dB μ V	Noise Floor dB μ V	RMS Range dB μ V	Peak Range dB μ V
0 dB	See Note 1	60 dB 74-134	38 dB 99-137	See Note 1	60 dB 74-134	38 dB 99-137	See Note 1	60 dB 74-134	38 dB 99-137
20 dB	See Note 1	60 dB 54-114	38 dB 79-117	See Note 1	60 dB 54-114	38 dB 79-117	See Note 1	60 dB 54-114	38 dB 79-117
40 dB	24	60 dB 34-94	38 dB 59-97	24	60 dB 34-94	38 dB 59-97	24	60 dB 34-94	38 dB 59-97
60 dB	14	50 dB 24-74	28 dB 49-77	14	50 dB 24-74	28 dB 49-77	14	50 dB 24-74	28 dB 49-77

Notes:

1. Under-Range (?) - The noise floor is below the measurement range of the analog to digital converter.
2. The data in the above table was obtained by electrically testing the HVM100.

Whole Body - Wm, Wj, Wk

Gain	Direct			Charge (1000pF)			ICP®		
	Noise Floor dB μ V	RMS Range dB μ V	Peak Range dB μ V	Noise Floor dB μ V	RMS Range dB μ V	Peak Range dB μ V	Noise Floor dB μ V	RMS Range dB μ V	Peak Range dB μ V
0 dB	See Note 1	60 dB 74-134	38 dB 99-137	See Note 1	60 dB 74-134	38 dB 99-137	See Note 1	60 dB 74-134	38 dB 99-137
20 dB	See Note 1	60 dB 54-114	38 dB 79-117	See Note 1	60 dB 54-114	38 dB 79-117	See Note 1	60 dB 54-114	38 dB 79-117
40 dB	24	60 dB 34-94	38 dB 59-97	24	60 dB 34-94	38 dB 59-97	24	60 dB 34-94	38 dB 59-97
60 dB	13	51 dB 23-74	29 dB 48-77	13	51 dB 23-74	29 dB 48-77	18	46 dB 28-74	24 dB 53-77

Notes:

1. Under-Range (?) - The noise floor is below the measurement range of the analog to digital converter.
2. The data in the above table was obtained by electrically testing the HVM100.

B**Glossary**

The following appendix contains definitions and explanations of terminology used in the HVM100

Table of equations

The following table gives many of the calculations the HVM performs to arrive at the results reported by the instrument.

Description	Equation
RMS Acceleration	$A_{eq} = \sqrt{\frac{1}{T} \int_0^T a_w^2(t) dt}$ <p> T = Integration time in seconds. $a_w(t)$ = instantaneous acceleration. t = Time, in seconds. </p> <p>The A_{eq} integration time is from Run to Reset; the display is updated once per second.</p>
RMS Acceleration in Decibels	$A_{eq} = 20 \text{Log} \sqrt{\frac{1}{T} \int_0^T \frac{a_w^2(t)}{a_o^2} (dt)} \quad \text{dB}$ <p>a_o = reference acceleration, 10^{-6} m/s^2 or 10^{-5} m/s^2 (user selectable)</p>

Description	Equation
Allowed Exposure Time	$[(2.8m/s^2)/(Aeq)]^2 \times 8hours$
Energy Equivalent RMS Acceleration	<p>The HVM100 measures the following quantities:</p> $A(8) = \sqrt{\frac{1}{8Hours} \int_0^T a_w^2(t) dt}$ $A(4) = \sqrt{\frac{1}{4Hours} \int_0^T a_w^2(t) dt}$ $A(2) = \sqrt{\frac{1}{2Hours} \int_0^T a_w^2(t) dt}$ $A(1) = \sqrt{\frac{1}{1Hours} \int_0^T a_w^2(t) dt}$
Running RMS Acceleration LINEAR	$Arms = \sqrt{\frac{1}{\tau} \int_{t_0-\tau}^{t_0} a_w^2(t) dt}$ <p>τ = Integration time, in seconds. t_o = Observation time</p> <p>The linear Arms integration time is controlled by the Averaging time setting; a new linear Arms value is calculated and displayed at the end of each integration period.</p>

Description	Equation
Running RMS Acceleration EXPONENTIAL	$Arms = \sqrt{\frac{1}{\tau} \int_{-\infty}^{t_0} a_w^2(t) \exp\left(\frac{t-t_0}{\tau}\right) dt}$ <p style="text-align: center;">τ = Time constant of the measurement.</p> <p>An averaging time of SLOW is equivalent to a time constant of 1 second.</p>
Vibration Dose Value	$VDV = \left(\int_0^T a_w^4(t) dt \right)^{\frac{1}{4}}$ <p>The <i>VDV</i> integration time is from Run to Reset; the display is updated once per second. The <i>VDV</i> is not calculated for units of dB or g.</p>
Maximum Transient Vibration Value	<p>A_{max} = maximum reading of all Arms readings from Run to Reset.</p> <p>The display is updated at the end of each Averaging time period.</p>
Minimum Transient Vibration Value	<p>A_{min} = minimum reading of all Arms readings from Run to Reset.</p> <p>The display is updated at the end of each Averaging time period.</p>
Long Term Maximum Peak	<p>Amp = peak level of the instantaneous weighted acceleration, $a_w(t)$; measured over the entire measurement period, from Run to Reset.</p> <p>The displayed Amp value is updated once per second.</p>

Description	Equation
Short Term Maximum Peak	<p>Peak = peak level of the instantaneous weighted acceleration, $a_w(t)$; measured during one Averaging time period.</p> <p>The peak measurement period is controlled by the Averaging time setting; a new Peak value is calculated and displayed at the end of each Averaging time period.</p>
Long Term Crest Factor	$CFmp = \frac{Amp}{Aeq}$ <p>The $CFmp$ measurement period is from Run to Reset; the display is updated once per second.</p>
Short Term Crest Factor	$CF = \frac{Peak}{Arms}$ <p>The CF measurement period is controlled by the Averaging time setting; a new CF value is calculated and displayed at the end of each Averaging time period. CF is not calculated if the Averaging time setting is SLOW.</p>
Summed Instantaneous Acceleration	$\sqrt{[K_x a_{wx}(t)]^2 + [K_y a_{wy}(t)]^2 + [K_z a_{wz}(t)]^2}$ <p>$a_{w\Sigma}(t)$ = instantaneous, summed acceleration $a_{wx}(t), a_{wy}(t), a_{wz}(t)$ = X, Y, and Z axis instantaneous acceleration K_x, K_y, K_z = X, Y, and Z axis Sum Factors</p> <p>The HVM100 uses the formula above to calculate the instantaneous, summed acceleration, $a_{w\Sigma}(t)$. This value is then used to calculate a sum quantity for the $A_{rms}, A_{min}, A_{max}, A_{mp}, A_{eq}, Peak, VDV,$ and PE. K factors affect only sum value and not individual axis data.</p>

C

Serial Interface Commands

The HVM100 is equipped with a serial port for communications with any standard RS-232 device. The most common use for this interface would be to either print, or to create a custom software program that can interface with the HVM100. The following is a list of commands and their descriptions to assist a programmer in communicating with the HVM100.

Setup and Query Commands

The setup/query commands are used to control the settings and query the status of the HVM100 parameters. The first 20 commands (S1 - S19, and Q1 - Q19) are reserved for system parameters. System parameter settings remain the same regardless of the operating mode. The remaining commands (S20 - S99, and Q20 - Q99) are for mode specific parameters. Mode specific parameter selections can vary based on the selected operating mode.

Setup commands can be sent at any time. If the HVM100 is running, and changing the parameter requires a reset, then the setup command will cause the instrument to automatically stop, reset, change the parameter setting and start running again. Query commands do not require a stop and reset of the HVM100.

Syntax for setup commands

The syntax for a setup command is Snn,i. The nn specifies the number of the parameter and 'i' is the desired setting.

The HVM100 returns an 'OK' for valid setup commands and 'NA' for invalid commands.

Syntax for Query commands

The syntax for a query command is Qnn. The nn specifies the parameter to be queried. The HVM100 responds to a query command by returning the current setting of the parameter. For indexed parameters (i.e. parameters for which there is a specific set of choices) the HVM100 returns the index number (i.e. 0, 1, 2, etc.). For alphanumeric parameters the HVM100 returns an ASCII string.

System Parameters (Q's and S's)

The following parameters are independent of the selected operating mode.

Command	Parameter	Setting
S0,yy	Date: Year	yy (00 to 99, 99 = 1999, 00 = 2000, 98 = 2098)
S1,mm	Date: Month	mm (01 to 12)
S2,dd	Date: Day	dd (01 to 31)
S3,hh	Time: Hour	hh (00 to 23)
S4,mm	Time: Minute	mm (00 to 59)
S5,ss	Time: Second	ss (00 to 59)
S6,...	Report Header 0	... = 1 to 16 characters
S7,...	Report Header 1	... = 1 to 16 characters

Command	Parameter	Setting
S8, . . .	Report Header 2	. . . = 1 to 16 characters
S9, i	Baud Rate	i = 0 to 3 0 = 2400 1 = 9600 2 = 38.4k 3 = 115.2k <i>NOTE: The baud rate change takes effect immediately after the "OK" response from the HVM100</i>

Mode Specific Parameters

The following parameters are dependent on which operating mode is selected:

Command	Parameter	Vibration	Hand Arm	Whole Body
S20, i	Operating Mode	i = 0 to 2 0 = Vibration 1 = Hand Arm 2 = Whole Body	i = 0 to 2 0 = Vibration 1 = Hand Arm 2 = Whole Body	i = 0 to 2 0 = Vibration 1 = Hand Arm 2 = Whole Body
S21, i	Detector Rate	i = 0 to 7 0 = Slow 1 = 1 2 = 2 3 = 5 4 = 10 5 = 20 6 = 30 7 = 60	i = 0 to 7 0 = Slow 1 = 1 2 = 2 3 = 5 4 = 10 5 = 20 6 = 30 7 = 60	i = 0 to 7 0 = Slow 1 = 1 2 = 2 3 = 5 4 = 10 5 = 20 6 = 30 7 = 60

Command	Parameter	Vibration	Hand Arm	Whole Body
S22, i	Gain X	i = 0 to 3 0 = 0 1 = 20 2 = 40 3 = 60	i = 0 to 3 0 = 0 1 = 20 2 = 40 3 = 60	i = 0 to 3 0 = 0 1 = 20 2 = 40 3 = 60
S23, i	Gain Y	i = 0 to 3 0 = 0 1 = 20 2 = 40 3 = 60	i = 0 to 3 0 = 0 1 = 20 2 = 40 3 = 60	i = 0 to 3 0 = 0 1 = 20 2 = 40 3 = 60
S24, i	Gain Z	i = 0 to 3 0 = 0 1 = 20 2 = 40 3 = 60	i = 0 to 3 0 = 0 1 = 20 2 = 40 3 = 60	i = 0 to 3 0 = 0 1 = 20 2 = 40 3 = 60
S25	Reserved			
S26	Reserved			
S27	Reserved			
S28, hh	Store Time: Hour	hh = 00 to 99	hh = 00 to 99	hh = 00 to 99
S29, mm	Store Time: Minute	mm = 01 to 59	mm = 01 to 59	mm = 01 to 59
S30, i	Accelerometer	i = 0 to 2 0 = Direct 1 = ICP® 2 = Charge	i = 0 to 2 0 = Direct 1 = ICP 2 = Charge	i = 0 to 2 0 = Direct 1 = ICP 2 = Charge

Command	Parameter	Vibration	Hand Arm	Whole Body
S31, i	Display Units	i = 0 to 5 0 = m/s ² 1 = cm/s ² 2 = ft/s ² 3 = in/s ² 4 = g 5 = dB	i = 0 to 5 0 = m/s ² 1 = cm/s ² 2 = ft/s ² 3 = in/s ² 4 = g 5 = dB	i = 0 to 5 0 = m/s ² 1 = cm/s ² 2 = ft/s ² 3 = in/s ² 4 = g 5 = dB
S32, i	Integration	i = 0 to 2 0 = None 1 = Single 2 = Double	Not Used	Not Used
S33	Reserved			
S34, nn	Sum Factor Kx	nn = 00 to 99 (Stored as tenths, i.e. 23 = 2.3)	nn = 00 to 99 (Stored as tenths, i.e. 23 = 2.3)	nn = 00 to 99 (Stored as tenths, i.e. 23 = 2.3)
S35, nn	Sum Factor Ky	nn = 00 to 99 (Stored as tenths, i.e. 23 = 2.3)	nn = 00 to 99 (Stored as tenths, i.e. 23 = 2.3)	nn = 00 to 99 (Stored as tenths, i.e. 23 = 2.3)
S36, nn	Sum Factor Kz	nn = 00 to 99 (Stored as tenths, i.e. 23 = 2.3)	nn = 00 to 99 (Stored as tenths, i.e. 23 = 2.3)	nn = 00 to 99 (Stored as tenths, i.e. 23 = 2.3)
S37, i	Weighting X	i = 0 to 3 0 = W _s 1 = F _a 2 = F _b 3 = F _c	Not Used (Only W _h weighting is available.)	i = 5 to 12 5 = W _m 6 = W _b 7 = W _c 8 = W _d 9 = W _e 10 = W _g 11 = W _j 12 = W _k

Command	Parameter	Vibration	Hand Arm	Whole Body
S38, i	Weighting Y	i = 0 to 3 0 = Ws 1 = Fa 2 = Fb 3 = Fc	Not Used (Only Wh weighting is available.)	i = 5 to 11 5 = Wm 6 = Wb 7 = Wc 8 = Wd 9 = We 10 = Wg 11 = Wj 12 = Wk
S39, i	Weighting Z	i = 0 to 3 0 = Ws 1 = Fa 2 = Fb 3 = Fc	Not Used (Only Wh weighting is available.)	i = 5 to 11 5 = Wm 6 = Wb 7 = Wc 8 = Wd 9 = We 10 = Wg 11 = Wj 12 = Wk
S40, i	AC/DC Output X	i = 0 to 9 0 = AC: Weighted 1 = AC: Bandlimit 2 = DC: rms 3 = DC: min 4 = DC: max 5 = DC: peak 6 = DC: rms Σ 7 = DC: min Σ 8 = DC: max Σ 9 = DC: peak Σ	i = 0 to 9 0 = AC: Weighted 1 = AC: Bandlimit 2 = DC: rms 3 = DC: min 4 = DC: max 5 = DC: peak 6 = DC: rms Σ 7 = DC: min Σ 8 = DC: max Σ 9 = DC: peak Σ	i = 0 to 9 0 = AC: Weighted 1 = AC: Bandlimit 2 = DC: rms 3 = DC: min 4 = DC: max 5 = DC: peak 6 = DC: rms Σ 7 = DC: min Σ 8 = DC: max Σ 9 = DC: peak Σ

Command	Parameter	Vibration	Hand Arm	Whole Body
S41, i	AC/DC Output Y	i = 0 to 9 0 = AC: Weighted 1 = AC: Bandlimit 2 = DC: rms 3 = DC: min 4 = DC: max 5 = DC: peak 6 = DC: rms Σ 7 = DC: min Σ 8 = DC: max Σ 9 = DC: peak Σ	i = 0 to 9 0 = AC: Weighted 1 = AC: Bandlimit 2 = DC: rms 3 = DC: min 4 = DC: max 5 = DC: peak 6 = DC: rms Σ 7 = DC: min Σ 8 = DC: max Σ 9 = DC: peak Σ	i = 0 to 9 0 = AC: Weighted 1 = AC: Bandlimit 2 = DC: rms 3 = DC: min 4 = DC: max 5 = DC: peak 6 = DC: rms Σ 7 = DC: min Σ 8 = DC: max Σ 9 = DC: peak Σ
S42, i	AC/DC Output Z	i = 0 to 9 0 = AC: Weighted 1 = AC: Bandlimit 2 = DC: rms 3 = DC: min 4 = DC: max 5 = DC: peak 6 = DC: rms Σ 7 = DC: min Σ 8 = DC: max Σ 9 = DC: peak Σ	i = 0 to 9 0 = AC: Weighted 1 = AC: Bandlimit 2 = DC: rms 3 = DC: min 4 = DC: max 5 = DC: peak 6 = DC: rms Σ 7 = DC: min Σ 8 = DC: max Σ 9 = DC: peak Σ	i = 0 to 9 0 = AC: Weighted 1 = AC: Bandlimit 2 = DC: rms 3 = DC: min 4 = DC: max 5 = DC: peak 6 = DC: rms Σ 7 = DC: min Σ 8 = DC: max Σ 9 = DC: peak Σ
S43, i	Auto Store	i = 0 to 2 0 = Off 1 = On 2 = AutoStop	i = 0 to 2 0 = Off 1 = On 2 = AutoStop	i = 0 to 2 0 = Off 1 = On 2 = AutoStop
S44, i	History Value	i = 0 to 1 0 = None 1 = Peak	i = 0 to 1 0 = None 1 = Peak	i = 0 to 1 0 = None 1 = Peak
S45	Setup/ File Name	... = 1 to 12 characters	... = 1 to 12 characters	... = 1 to 12 characters

Command	Parameter	Vibration	Hand Arm	Whole Body
S46	Sensitivity X Enter command as S46,n.nnne±nn	n.nnne±nn = Sensitivity of accelerometer. Units: mV/g for Direct and ICP® pC/g for Charge	n.nnne±nn = Sensitivity of accelerometer. Units: mV/g for Direct and ICP. pC/g for Charge	n.nnne±nn = Sensitivity of accelerometer. Units: mV/g for Direct and ICP. pC/g for Charge
S47	Sensitivity Y Enter command as S47,n.nnne±nn	n.nnne±nn = Sensitivity of accelerometer. Units: mV/g for Direct and ICP. pC/g for Charge	n.nnne±nn = Sensitivity of accelerometer. Units: mV/g for Direct and ICP. pC/g for Charge	n.nnne±nn = Sensitivity of accelerometer. Units: mV/g for Direct and ICP. pC/g for Charge
S48	Sensitivity Z Enter command as S48,n.nnne±nn	n.nnne±nn = Sensitivity of accelerometer. Units: mV/g for Direct and ICP. pC/g for Charge	n.nnne±nn = Sensitivity of accelerometer. Units: mV/g for Direct and ICP. pC/g for Charge	n.nnne±nn = Sensitivity of accelerometer. Units: mV/g for Direct and ICP. pC/g for Charge
S49	Cal Level Enter command as S49,n.nnne±nn	n.nnne±nn = Output level of calibrator Units are g	n.nnne±nn = Output level of calibrator Units are g	n.nnne±nn = Output level of calibrator Units are g
S50, i	Print History	i = 0 to 1 0 = No 1 = Yes	i = 0 to 1 0 = No 1 = Yes	i = 0 to 1 0 = No 1 = Yes

Command	Parameter	Vibration	Hand Arm	Whole Body
S51, i	dB reference	i = 0 to 1 0 = 1e-05 m/s ² 1 = 1e-06 m/s ²	i = 0 to 1 0 = 1e-05 m/s ² 1 = 1e-06 m/s ²	i = 0 to 1 0 = 1e-05 m/s ² 1 = 1e-06 m/s ²
S52, i	Exposure re. Hand Arm Exposure action value	Not applicable to this mode, but can be set or read	i = 0 to 2 0 = 2.8 m/s ² 1 = 2.5 m/s ² 2 = 5.0 m/s ²	Not applicable to this mode, but can be set or read

Read Data Commands

NOTE: An R1 command returns the following data: Larson Davis HVM100 nnnnn rev x.xx (nnnnn is the 5 digit serial number and x.xx is the firmware revision). Not to be confused with Rx1, Ry1, Rz1 or Rs1.

The read commands are used to read data from the data buffer. The syntax for a read command is Rcnn. The c indicates which channel to read (X, Y, Z, or S). The nn indicates which data to read.

Hint: *The HVM100 always returns data in decibels, referenced to (10⁻⁶ m/s²).*

R Command nn	Vibration	Hand Arm	Whole Body
0	Elapsed Time	Elapsed Time	Elapsed Time
1	Arms	Arms	Arms
2	Amin	Amin	Amin
3	Amax	Amax	Amax
4	PEAK	PEAK	PEAK
5	Amp	Amp	Amp
6	Aeq	Aeq	Aeq
7	Unused	Aeq1	Unused
8	Unused	Aeq2	Unused
9	Unused	Aeq4	Unused

R Command nn	Vibration	Hand Arm	Whole Body
10	Unused	Aeq8	Unused
11	Unused	Unused	VDV
12	Unused	Unused	CF
13	Unused	Unused	CFmp
14	Unused	Allowed Exposure Time	Unused

Read Time History Commands

The read time history commands are used to read data from the time history buffer. The syntax for this command is Hcnnn,i. The c indicates which channel to read (X, Y, Z, or S). The nnn is an index for indicating which sample to read.

Example: nnn = 0 is the last sample stored, nnn = 1, is the next to last sample stored.

The i indicates which data to read (i = 0 for Arms, or i = 1 for Peak). The commands listed in the following table are also available. The date information (H0 - H5) refers to the starting date/time of the first history record.

Hint: *The HVM100 always returns data in decibels, referenced to (10^{-6} m/s²).*

Command	Parameter	Settings
H0	History: Year	YY (00 to 99, 99 = 1999, 00 = 2000, 98 = 2098)
H1	History: Month	mm (01 to 12)
H2	History: Day	dd (01 to 31)
H3	History: Hour	hh (00 to 23)

Command	Parameter	Settings
H4	History: Minute	mm (00 to 59)
H5	History: Second	ss (00 to 59)
H6	Number of Samples	000 to 239
H7	Number of Wraps	Returns the number of times the buffer has been completely filled. After the buffer is filled, new data is simply written over the existing data. (i.e. the buffer always contains the last 240 samples, or 120 samples if Peak is also stored.)

┌ 1 = Running 0 = stopped
 └ 1 = Paused (!) 0 = Not Paused
 ┌ 1 = File Data 0 = Not Paused

┌ 1 = X is currently overloaded
 └ 1 = Y is currently overloaded
 ┌ 1 = Z is currently overloaded

┌ 1 = X is currently overloaded since reset
 └ 1 = Y is currently overloaded
 ┌ 1 = Z is currently overloaded

Control Commands

Command	Description	Notes
M0	Status	<p>This command returns 3 ASCII bytes separated by commas (i.e. byte1, byte2, byte3). For example, for a status of 4, 3, 7, the 4 indicates that the currently available data (currently displayed data) is file data. The 4 also indicates that a pause did not occur during the time the data was collected. Finally, the 4 also conveys that the instrument is currently stopped. The 3 indicates that the X and Y channels are currently overloaded. The 7 indicates that the X, Y, Z latching overload indicators are all set.</p> <p>The 3 least significant bits of each byte are used to communicate status information as shown below.</p> <p>Byte1 xxxxxn</p> <p>Byte2 xxxxxn</p> <p>Byte3 xxxxxn</p>
M1	Run	HVM100 returns “OK” for valid command.
M2	Stop	HVM100 returns “OK” for valid command.
M3	Reset	HVM100 returns “OK” for valid command.
M4, n	Store Setup n = 0 to 9	HVM100 will store the current setup in the setup register indicated by n (0 is default). Returns “OK” for valid command.

Command	Description	Notes
M5, n	Recall Setup n = 0 to 99	HVM100 will recall the setup indicated by n (0 is default). Returns "OK" for valid command. Returns "NO" if a setup has never been stored in the nth setup location.
M6, n	Store File n = 0 to 99	HVM100 will store a file in the location specified by n (0 is default). Returns "OK" for valid command.
M7, n	Recall File n = 0 to 99	HVM100 will recall the file specified by n (0 is default). Returns "OK" for valid command. Returns "NO" if a file has never been stored in the nth file location. Returns "NA" if the file location is not available (i.e. less than 0 or greater than 99).
M8, n	File Empty? n = 0 to 99	HVM100 will respond as to whether or not the file indicated by n (0 is default) is empty (1 = full, 0 = empty).
M9	Reserved	
M10	Print	HVM100 will print report
M11	Battery	HVM returns current battery level (volts)
M12	External Power	HVM returns current external power level (volts)
M13	Reserved	
M123459	Erase Setups	Erases all setups (HVM100 responds to command by counting down from 9 to 0 while erasing setups), final response is "OK"
M123457	Erase Files	Erases all files (HVM100 responds to command by counting down from 9 to 0 while erasing

D

Frequency Response Curves

The following are typical frequency response curves for the HVM100. Specifications are subject to change without notice. Numerical values given are typical. Refer to specific calibration or test results for accurate data on a specific unit.



Larson Davis Model: HVM100; Serial Number: 00103
Certificate of X Fa Electrical Conformance

This Type 1 Human Vibration Meter was calibrated using a reference 10.0 Hz sine wave at a level of 0.001 Vrms. This calibration level is equivalent to 100.0 dB or 0.10 m/s² (dB reference = 1e-6 m/s²) with an accelerometer sensitivity of 98.1 mV/g. The instrument's frequency response (Fa weighted, 60 dB gain, Direct input) was then electrically tested as specified in ISO 8041:1990(E).

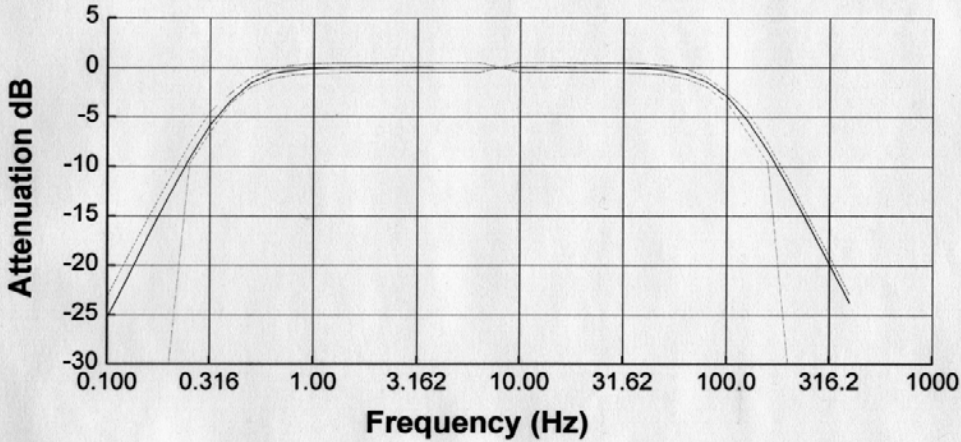

Freq (Hz)	Theor	Measured	Error	LD Tolerance	Freq (Hz)	Theor	Measured	Error	LD Tolerance
0.10	-24.1	-25.2	-1.1	+1.0, -998.0	7.94	+0.0	+0.0	+0.0	+0.0, +0.0
0.13	-20.1	-21.2	-1.1	+1.0, -998.0	10.00	+0.0	+0.0	+0.0	+0.5, -0.5
0.16	-16.2	-17.0	-0.8	+1.0, -998.0	12.59	+0.0	+0.0	+0.0	+0.5, -0.5
0.20	-12.3	-12.9	-0.6	+1.0, -998.0	15.85	+0.0	+0.0	+0.0	+0.5, -0.5
0.25	-8.7	-9.1	-0.4	+1.0, -1.0	19.95	-0.0	-0.0	+0.0	+0.5, -0.5
0.32	-5.5	-5.8	-0.3	+1.0, -1.0	25.12	-0.0	-0.0	+0.0	+0.5, -0.5
0.40	-3.0	-3.3	-0.3	+0.5, -0.5	31.62	-0.0	-0.0	+0.0	+0.5, -0.5
0.50	-1.5	-1.5	-0.1	+0.5, -0.5	39.81	-0.1	-0.1	+0.0	+0.5, -0.5
0.63	-0.6	-0.6	+0.0	+0.5, -0.5	50.12	-0.3	-0.2	+0.0	+0.5, -0.5
0.79	-0.3	-0.3	-0.1	+0.5, -0.5	63.10	-0.6	-0.6	+0.0	+0.5, -0.5
1.00	-0.1	-0.1	+0.0	+0.5, -0.5	79.43	-1.5	-1.4	+0.0	+0.5, -0.5
1.26	-0.0	-0.0	+0.0	+0.5, -0.5	100.00	-3.0	-2.9	+0.1	+0.5, -0.5
1.59	-0.0	+0.0	+0.0	+0.5, -0.5	125.90	-5.5	-5.3	+0.1	+1.0, -1.0
2.00	-0.0	-0.0	+0.0	+0.5, -0.5	158.50	-8.6	-8.4	+0.2	+1.0, -1.0
2.51	+0.0	-0.0	+0.0	+0.5, -0.5	199.50	-12.3	-12.0	+0.2	+1.0, -998.0
3.16	+0.0	+0.0	+0.0	+0.5, -0.5	251.20	-16.1	-15.8	+0.3	+1.0, -998.0
3.98	+0.0	-0.0	+0.0	+0.5, -0.5	316.20	-20.0	-19.8	+0.2	+1.0, -998.0
5.01	+0.0	-0.0	+0.0	+0.5, -0.5	398.10	-24.0	-23.8	+0.2	+1.0, -998.0
6.31	+0.0	-0.0	+0.0	+0.5, -0.5					

Technician: Craig Test Date: Dec 03, 1999



Larson Davis Model: HVM100; Serial Number: 00103
Certificate of X Fb Electrical Conformance

This Type 1 Human Vibration Meter was calibrated using a reference 10.0 Hz sine wave at a level of 0.001 Vrms. This calibration level is equivalent to 100.0 dB or 0.10 m/s² (dB reference = 1e-6 m/s²) with an accelerometer sensitivity of 98.1 mV/g. The instrument's frequency response (Fb weighted, 60 dB gain, Direct input) was then electrically tested as specified in ISO 8041:1990(E).

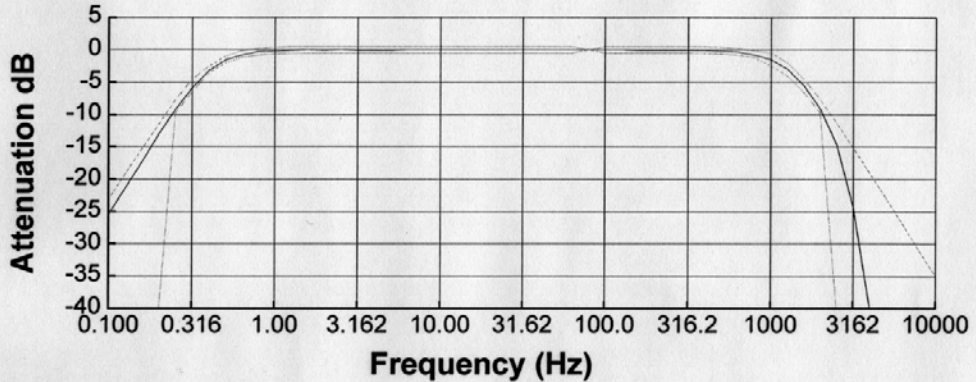

Freq (Hz)	Theor	Measured	Error	LD Tolerance	Freq (Hz)	Theor	Measured	Error	LD Tolerance
0.10	-24.1	-25.4	-1.3	+1.0, -998.0	39.81	+0.0	+0.0	+0.0	+0.5, -0.5
0.13	-20.1	-21.3	-1.1	+1.0, -998.0	50.12	+0.0	+0.0	+0.0	+0.5, -0.5
0.16	-16.2	-17.1	-0.9	+1.0, -998.0	63.10	+0.0	+0.0	+0.0	+0.5, -0.5
0.20	-12.3	-12.8	-0.5	+1.0, -998.0	79.43	+0.0	+0.0	+0.0	+0.0, +0.0
0.25	-8.7	-9.2	-0.5	+1.0, -1.0	100.00	+0.0	+0.0	+0.0	+0.5, -0.5
0.32	-5.5	-5.9	-0.4	+1.0, -1.0	125.90	+0.0	+0.0	+0.0	+0.5, -0.5
0.40	-3.0	-3.2	-0.2	+0.5, -0.5	158.50	+0.0	+0.0	-0.1	+0.5, -0.5
0.50	-1.5	-1.6	-0.1	+0.5, -0.5	199.50	+0.0	+0.0	-0.1	+0.5, -0.5
0.63	-0.6	-0.8	-0.1	+0.5, -0.5	251.20	-0.0	-0.1	+0.0	+0.5, -0.5
0.79	-0.3	-0.3	+0.0	+0.5, -0.5	316.20	-0.0	-0.1	+0.0	+0.5, -0.5
1.00	-0.1	-0.2	-0.1	+0.5, -0.5	398.10	-0.0	-0.1	+0.0	+0.5, -0.5
1.26	-0.0	-0.1	+0.0	+0.5, -0.5	501.20	-0.1	-0.2	-0.1	+0.5, -0.5
1.59	+0.0	+0.0	+0.0	+0.5, -0.5	631.00	-0.3	-0.4	-0.1	+0.5, -0.5
2.00	+0.0	-0.1	+0.0	+0.5, -0.5	794.30	-0.6	-0.8	-0.1	+0.5, -0.5
2.51	+0.0	+0.0	+0.0	+0.5, -0.5	1000.00	-1.5	-1.5	+0.0	+1.0, -1.0
3.16	+0.0	-0.1	-0.1	+0.5, -0.5	1259.00	-3.0	-3.0	+0.1	+1.0, -1.0
3.98	+0.0	-0.1	-0.1	+0.5, -0.5	1585.00	-5.5	-5.5	+0.0	+1.0, -1.0
5.01	+0.0	-0.1	-0.1	+0.5, -0.5	1995.00	-8.6	-9.1	-0.4	+1.0, -1.0
6.31	+0.0	+0.0	+0.0	+0.5, -0.5	2512.00	-12.3	-14.6	-2.3	+1.0, -998.0
7.94	+0.0	+0.0	+0.0	+0.5, -0.5	3162.00	-16.1	-24.3	-8.1	+1.0, -998.0
10.00	+0.0	+0.0	+0.0	+0.5, -0.5	3981.00	-20.0	-46.4	-26.3	+1.0, -998.0
12.59	+0.0	+0.0	+0.0	+0.5, -0.5	5012.00	-24.0	-70.0	-45.9	+1.0, -998.0
15.85	+0.0	+0.0	+0.0	+0.5, -0.5	6310.00	-28.0	-71.5	-43.4	+1.0, -998.0
19.95	+0.0	+0.0	+0.0	+0.5, -0.5	7943.00	-32.0	-71.2	-39.2	+1.0, -998.0
25.12	+0.0	+0.0	+0.0	+0.5, -0.5	10000.00	-36.0	-71.0	-35.0	+1.0, -998.0
31.62	+0.0	+0.0	+0.0	+0.5, -0.5					

Technician: Craig

Test Date: Dec 03, 1999



Larson Davis Model: HVM100; Serial Number: 00103
Certificate of X Fc Electrical Conformance

This Type 1 Human Vibration Meter was calibrated using a reference 10.0 Hz sine wave at a level of 0.001 Vrms. This calibration level is equivalent to 100.0 dB or 0.10 m/s² (dB reference = 1e-6 m/s²) with an accelerometer sensitivity of 98.1 mV/g. The instrument's frequency response (Fc weighted, 60 dB gain, Direct input) was then electrically tested as specified in ISO 8041:1990(E).

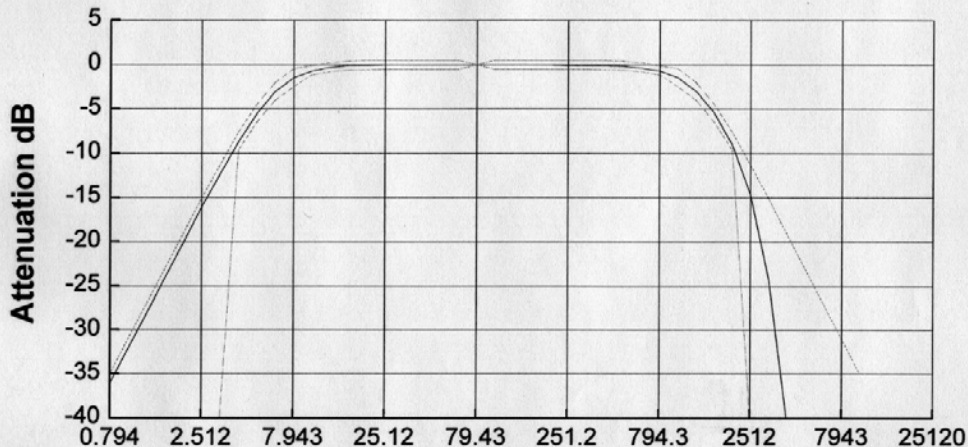

Frequency (Hz)										
Freq (Hz)	Theor	Measured	Error	LD Tolerance	Freq (Hz)	Theor	Measured	Error	LD Tolerance	
0.79	-36.0	-36.0	+0.0	+1.0, -998.0	100.00	+0.0	+0.0	+0.0	+0.5, -0.5	
1.00	-32.0	-32.1	-0.1	+1.0, -998.0	125.90	+0.0	+0.0	+0.0	+0.5, -0.5	
1.26	-28.0	-28.1	-0.1	+1.0, -998.0	158.50	+0.0	+0.0	+0.0	+0.5, -0.5	
1.59	-24.0	-24.1	+0.0	+1.0, -998.0	199.50	+0.0	-0.0	+0.0	+0.5, -0.5	
2.00	-20.0	-20.1	-0.1	+1.0, -998.0	251.20	-0.0	-0.1	-0.1	+0.5, -0.5	
2.51	-16.1	-16.1	+0.0	+1.0, -998.0	316.20	-0.0	-0.1	-0.1	+0.5, -0.5	
3.16	-12.3	-12.3	+0.0	+1.0, -998.0	398.10	-0.0	-0.1	-0.1	+0.5, -0.5	
3.98	-8.6	-8.7	-0.1	+1.0, -1.0	501.20	-0.1	-0.2	-0.1	+0.5, -0.5	
5.01	-5.5	-5.5	+0.0	+1.0, -1.0	631.00	-0.3	-0.4	-0.1	+0.5, -0.5	
6.31	-3.0	-3.0	+0.0	+1.0, -1.0	794.30	-0.6	-0.7	-0.1	+0.5, -0.5	
7.94	-1.5	-1.5	+0.0	+1.0, -1.0	1000.00	-1.5	-1.5	+0.0	+1.0, -1.0	
10.00	-0.6	-0.7	-0.1	+0.5, -0.5	1259.00	-3.0	-3.0	+0.0	+1.0, -1.0	
12.59	-0.3	-0.3	+0.0	+0.5, -0.5	1585.00	-5.5	-5.4	+0.1	+1.0, -1.0	
15.85	-0.1	-0.1	+0.0	+0.5, -0.5	1995.00	-8.6	-9.1	-0.5	+1.0, -1.0	
19.95	-0.0	-0.1	-0.1	+0.5, -0.5	2512.00	-12.3	-14.6	-2.3	+1.0, -998.0	
25.12	-0.0	+0.0	+0.0	+0.5, -0.5	3162.00	-16.1	-24.3	-8.2	+1.0, -998.0	
31.62	-0.0	+0.0	+0.0	+0.5, -0.5	3981.00	-20.0	-46.4	-26.4	+1.0, -998.0	
39.81	+0.0	+0.0	+0.0	+0.5, -0.5	5012.00	-24.0	-69.9	-45.9	+1.0, -998.0	
50.12	+0.0	+0.0	+0.0	+0.5, -0.5	6310.00	-28.0	-71.4	-43.4	+1.0, -998.0	
63.10	+0.0	+0.0	+0.0	+0.5, -0.5	7943.00	-32.0	-71.1	-39.1	+1.0, -998.0	
79.43	+0.0	+0.0	+0.0	+0.0, +0.0	10000.00	-36.0	-71.1	-35.1	+1.0, -998.0	

Technician: Craig

Test Date: Dec 03, 1999



Larson Davis Model: HVM100; Serial Number: 00103
Certificate of X W_mElectrical Conformance

This Type 1 Human Vibration Meter was calibrated using a reference 10.0 Hz sine wave at a level of 0.001 Vrms. This calibration level is equivalent to 100.0 dB or 0.10 m/s² (dB reference = 1e-6 m/s²) with an accelerometer sensitivity of 98.1 mV/g. The instrument's frequency response (WB weighted, 60 dB gain, Direct input) was then electrically tested as specified in ISO 8041:1990(E).

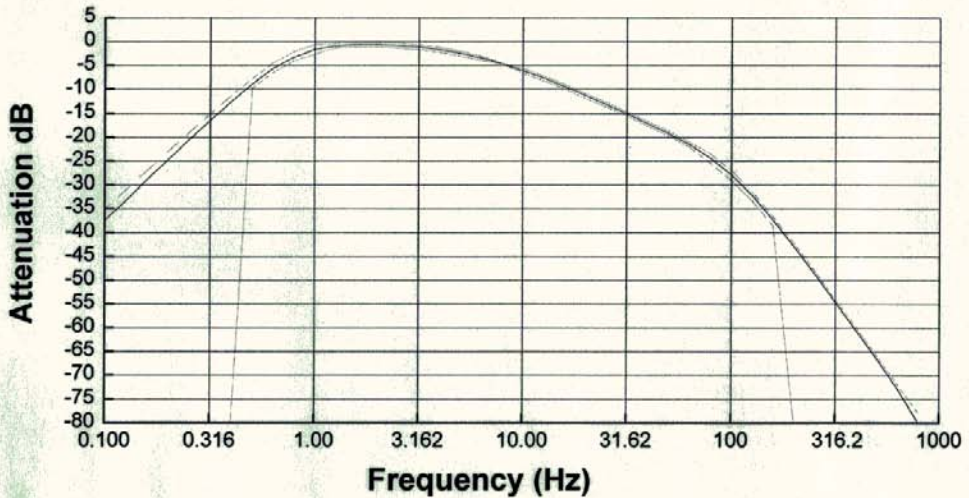

Freq (Hz)	Theor	Measured	Error	LD Tolerance	Freq (Hz)	Theor	Measured	Error	LD Tolerance
0.10	-36.0	-37.3	-1.3	+1.0, -998.0	10.00	-6.1	-6.1	+0.0	+0.5, -0.5
0.13	-32.0	-33.3	-1.3	+1.0, -998.0	12.59	-7.7	-7.6	+0.1	+0.5, -0.5
0.16	-28.0	-28.9	-0.9	+1.0, -998.0	15.85	-9.4	-9.4	+0.0	+0.5, -0.5
0.20	-24.0	-24.7	-0.7	+1.0, -998.0	19.95	-11.3	-11.2	+0.0	+0.5, -0.5
0.25	-20.0	-20.5	-0.4	+1.0, -998.0	25.12	-13.1	-13.1	+0.0	+0.5, -0.5
0.32	-16.1	-16.5	-0.4	+1.0, -998.0	31.62	-15.1	-15.0	+0.1	+0.5, -0.5
0.40	-12.3	-12.5	-0.3	+1.0, -998.0	39.81	-17.1	-17.1	+0.0	+0.5, -0.5
0.50	-8.7	-8.9	-0.2	+1.0, -1.0	50.12	-19.2	-19.2	+0.0	+0.5, -0.5
0.63	-5.5	-5.6	-0.1	+1.0, -1.0	63.10	-21.6	-21.6	+0.0	+0.5, -0.5
0.79	-3.1	-3.3	-0.2	+1.0, -1.0	79.43	-24.4	-24.3	+0.1	+1.0, -1.0
1.00	-1.6	-1.6	+0.0	+1.0, -1.0	100.00	-27.9	-27.8	+0.1	+1.0, -1.0
1.26	-0.9	-0.9	+0.0	+0.5, -0.5	125.90	-32.4	-32.2	+0.1	+1.0, -1.0
1.59	-0.6	-0.6	-0.1	+0.5, -0.5	158.50	-37.5	-37.3	+0.2	+1.0, -1.0
2.00	-0.6	-0.6	+0.0	+0.5, -0.5	199.50	-43.2	-42.9	+0.3	+1.0, -998.0
2.51	-0.8	-0.8	+0.0	+0.5, -0.5	251.20	-49.0	-48.7	+0.3	+1.0, -998.0
3.16	-1.2	-1.1	+0.0	+0.5, -0.5	316.20	-55.0	-54.6	+0.3	+1.0, -998.0
3.98	-1.7	-1.7	+0.0	+0.5, -0.5	398.10	-60.9	-60.6	+0.3	+1.0, -998.0
5.01	-2.5	-2.4	+0.1	+0.5, -0.5	501.20	-66.9	-66.6	+0.3	+1.0, -998.0
6.31	-3.5	-3.5	+0.0	+0.5, -0.5	631.00	-72.9	-72.8	+0.1	+1.0, -998.0
7.94	-4.7	-4.7	+0.0	+0.0, +0.0	794.30	-78.9	-80.4	-1.5	+1.0, -998.0

Technician: Craig Test Date: Dec 03, 1999

Note: W_m filter, compatible with ISO 6954-2000, Merchant Ship vibration, was previously referred to as "WB."



**Larson Davis Model: HVM100; Serial Number: 00362
Certificate of X Wb Electrical Conformance**

This Type 1 Human Vibration Meter was calibrated using a reference 79.6 Hz sine wave at a level of 0.001 Vrms. This calibration level is equivalent to 100.0 dB or 0.10 m/s² (dB reference = 1e-6 m/s²) with an accelerometer sensitivity of 98.1 mV/g. The instrument's frequency response (Wb weighted, 60 dB gain, Direct input) was then electrically tested as specified in ISO 8041:1990(E).

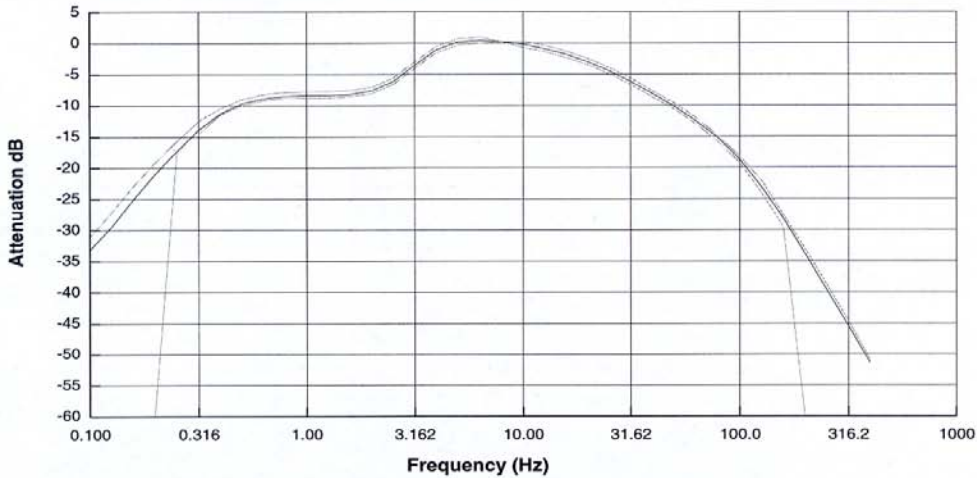

Freq (Hz)	Theor	Measured	Error	LD Tolerance	Freq (Hz)	Theor	Measured	Error	LD Tolerance
0.10	-32.0	-33.1	-1.1	+1.0, -998.0	7.94	+0.2	+0.2	+0.0	+0.0, +0.0
0.13	-28.2	-29.4	-1.2	+1.0, -998.0	10.00	-0.2	-0.2	+0.0	+0.5, -0.5
0.16	-24.0	-25.1	-1.2	+1.0, -998.0	12.59	-0.9	-0.9	+0.0	+0.5, -0.5
0.20	-20.2	-21.0	-0.8	+1.0, -998.0	15.85	-1.8	-1.8	+0.0	+0.5, -0.5
0.25	-16.7	-17.3	-0.6	+1.0, -1.0	19.95	-3.0	-3.0	+0.0	+0.5, -0.5
0.32	-13.5	-13.9	-0.4	+1.0, -1.0	25.12	-4.4	-4.5	+0.0	+0.5, -0.5
0.40	-11.0	-11.3	-0.4	+0.5, -0.5	31.62	-6.2	-6.2	+0.0	+0.5, -0.5
0.50	-9.5	-9.7	-0.2	+0.5, -0.5	39.81	-8.1	-8.1	+0.0	+0.5, -0.5
0.63	-8.7	-8.9	-0.2	+0.5, -0.5	50.12	-10.1	-10.1	+0.0	+0.5, -0.5
0.79	-8.4	-8.5	-0.1	+0.5, -0.5	63.10	-12.4	-12.5	-0.1	+0.5, -0.5
1.00	-8.3	-8.4	-0.1	+0.5, -0.5	79.43	-15.3	-15.2	+0.2	+0.5, -0.5
1.26	-8.3	-8.4	-0.1	+0.5, -0.5	100.00	-18.7	-18.7	+0.0	+0.5, -0.5
1.59	-8.1	-8.2	-0.1	+0.5, -0.5	125.90	-23.0	-23.1	-0.1	+1.0, -1.0
2.00	-7.6	-7.6	+0.0	+0.5, -0.5	158.50	-28.6	-28.2	+0.4	+1.0, -1.0
2.51	-6.1	-6.1	+0.0	+0.5, -0.5	199.50	-34.0	-33.8	+0.2	+1.0, -998.0
3.16	-3.6	-3.6	+0.0	+0.5, -0.5	251.20	-39.7	-39.6	+0.1	+1.0, -998.0
3.98	-1.0	-1.1	-0.1	+0.5, -0.5	316.20	-45.7	-45.5	+0.2	+1.0, -998.0
5.01	+0.2	+0.2	+0.0	+0.5, -0.5	398.10	-51.8	-51.4	+0.5	+1.0, -998.0
6.31	+0.5	+0.5	+0.0	+0.5, -0.5					

This instrument is in compliance with ISO 8041:1990(E) for Type 1 human vibration meters when used with a Type 1 accelerometer.

Technician: Craig Test Date: Dec 17,2001



Larson Davis Model: HVM100; Serial Number: 00103
Certificate of X Wc Electrical Conformance

This Type 1 Human Vibration Meter was calibrated using a reference 10.0 Hz sine wave at a level of 0.001 Vrms. This calibration level is equivalent to 100.0 dB or 0.10 m/s² (dB reference = 1e-6 m/s²) with an accelerometer sensitivity of 98.1 mV/g. The instrument's frequency response (Wc weighted, 60 dB gain, Direct input) was then electrically tested as specified in ISO 8041:1990(E).

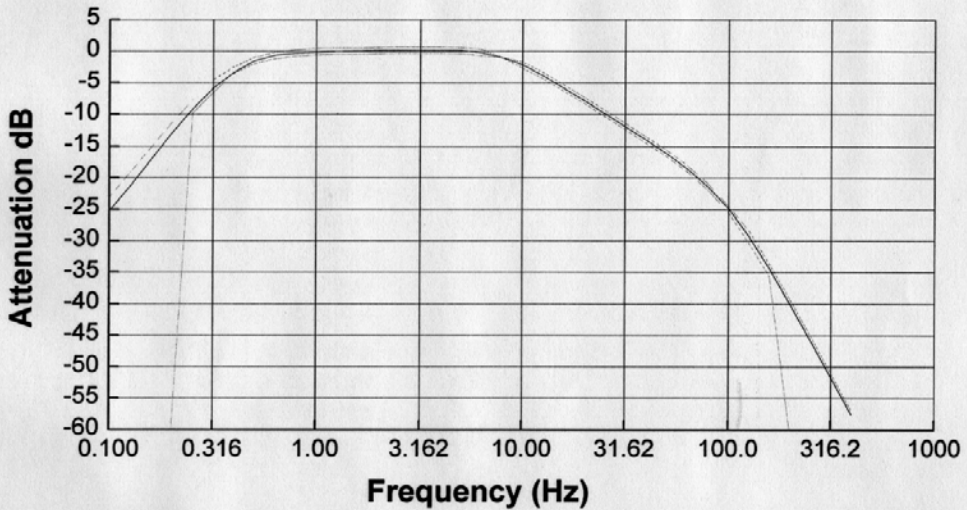

Freq (Hz)	Theor	Measured	Error	LD Tolerance	Freq (Hz)	Theor	Measured	Error	LD Tolerance
0.10	-24.1	-25.3	-1.2	+1.0, -998.0	7.94	-1.0	-1.0	+0.0	+0.0, +0.0
0.13	-20.1	-21.3	-1.2	+1.0, -998.0	10.00	-2.2	-2.2	+0.0	+0.5, -0.5
0.16	-16.2	-17.1	-0.9	+1.0, -998.0	12.59	-3.8	-3.9	+0.0	+0.5, -0.5
0.20	-12.3	-12.9	-0.6	+1.0, -998.0	15.85	-5.7	-5.8	+0.0	+0.5, -0.5
0.25	-8.7	-9.2	-0.5	+1.0, -1.0	19.95	-7.8	-7.8	+0.0	+0.5, -0.5
0.32	-5.5	-5.8	-0.3	+1.0, -1.0	25.12	-9.8	-9.8	+0.0	+0.5, -0.5
0.40	-3.0	-3.4	-0.3	+0.5, -0.5	31.62	-11.9	-11.9	+0.0	+0.5, -0.5
0.50	-1.5	-1.6	-0.1	+0.5, -0.5	39.81	-14.0	-14.0	+0.0	+0.5, -0.5
0.63	-0.6	-0.7	+0.0	+0.5, -0.5	50.12	-16.1	-16.2	+0.0	+0.5, -0.5
0.79	-0.3	-0.4	-0.1	+0.5, -0.5	63.10	-18.5	-18.6	+0.0	+0.5, -0.5
1.00	-0.1	-0.2	-0.1	+0.5, -0.5	79.43	-21.4	-21.4	+0.0	+0.5, -0.5
1.26	+0.0	-0.0	+0.0	+0.5, -0.5	100.00	-24.9	-24.9	+0.1	+0.5, -0.5
1.59	+0.1	+0.1	+0.0	+0.5, -0.5	125.90	-29.4	-29.3	+0.1	+1.0, -1.0
2.00	+0.1	+0.1	+0.0	+0.5, -0.5	158.50	-34.6	-34.4	+0.2	+1.0, -1.0
2.51	+0.2	+0.1	+0.0	+0.5, -0.5	199.50	-40.2	-40.0	+0.2	+1.0, -998.0
3.16	+0.2	+0.1	-0.1	+0.5, -0.5	251.20	-46.0	-45.9	+0.2	+1.0, -998.0
3.98	+0.2	+0.1	-0.1	+0.5, -0.5	316.20	-52.0	-51.7	+0.3	+1.0, -998.0
5.01	+0.1	+0.1	+0.0	+0.5, -0.5	398.10	-58.0	-57.7	+0.3	+1.0, -998.0
6.31	-0.2	-0.3	+0.0	+0.5, -0.5					

Technician: Craig

Test Date: Dec 03, 1999



Larson Davis Model: HVM100; Serial Number: 00103
Certificate of X Wd Electrical Conformance

This Type 1 Human Vibration Meter was calibrated using a reference 10.0 Hz sine wave at a level of 0.001 Vrms. This calibration level is equivalent to 100.0 dB or 0.10 m/s² (dB reference = 1e-6 m/s²) with an accelerometer sensitivity of 98.1 mV/g. The instrument's frequency response (Wd weighted, 60 dB gain, Direct input) was then electrically tested as specified in ISO 8041:1990(E).

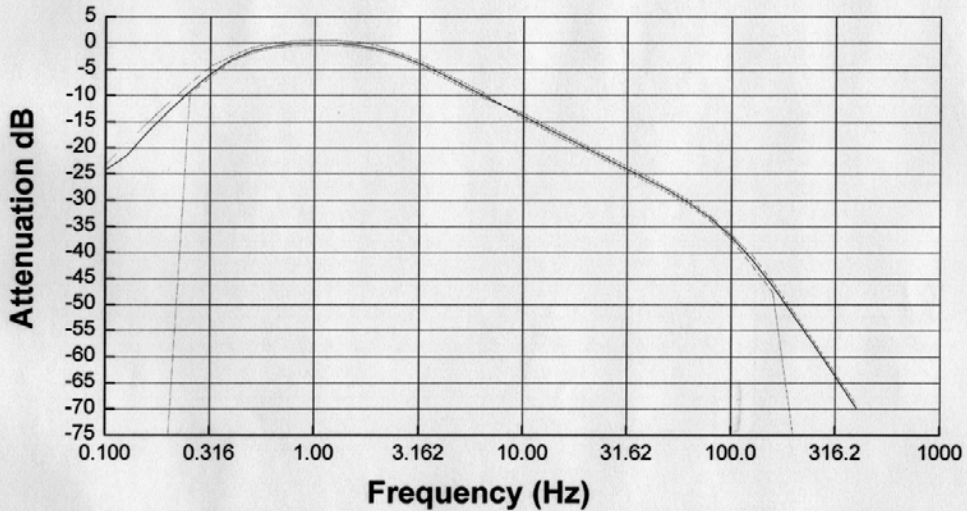

Freq (Hz)	Theor	Measured	Error	LD Tolerance	Freq (Hz)	Theor	Measured	Error	LD Tolerance
0.10	-24.1	-24.1	+0.0	+1.0, -998.0	7.94	-11.9	-11.9	+0.0	+0.0, +0.0
0.13	-20.1	-21.4	-1.3	+1.0, -998.0	10.00	-13.9	-13.9	+0.0	+0.5, -0.5
0.16	-16.2	-16.9	-0.7	+1.0, -998.0	12.59	-15.9	-16.0	+0.0	+0.5, -0.5
0.20	-12.3	-12.9	-0.5	+1.0, -998.0	15.85	-18.0	-18.0	+0.0	+0.5, -0.5
0.25	-8.7	-9.2	-0.5	+1.0, -1.0	19.95	-20.0	-20.0	+0.0	+0.5, -0.5
0.32	-5.5	-5.8	-0.3	+1.0, -1.0	25.12	-22.0	-22.0	+0.0	+0.5, -0.5
0.40	-3.0	-3.1	-0.2	+0.5, -0.5	31.62	-24.0	-24.1	-0.1	+0.5, -0.5
0.50	-1.4	-1.5	-0.1	+0.5, -0.5	39.81	-26.1	-26.1	+0.0	+0.5, -0.5
0.63	-0.5	-0.7	-0.2	+0.5, -0.5	50.12	-28.2	-28.3	+0.0	+0.5, -0.5
0.79	-0.1	-0.1	+0.0	+0.5, -0.5	63.10	-30.6	-30.7	+0.0	+0.5, -0.5
1.00	+0.1	+0.0	-0.1	+0.5, -0.5	79.43	-33.4	-33.5	+0.0	+0.5, -0.5
1.26	+0.1	+0.0	+0.0	+0.5, -0.5	100.00	-37.0	-37.0	+0.0	+0.5, -0.5
1.59	-0.3	-0.3	-0.1	+0.5, -0.5	125.90	-41.4	-41.4	+0.1	+1.0, -1.0
2.00	-1.0	-1.1	-0.1	+0.5, -0.5	158.50	-46.6	-46.5	+0.2	+1.0, -1.0
2.51	-2.2	-2.3	+0.0	+0.5, -0.5	199.50	-52.2	-52.0	+0.3	+1.0, -998.0
3.16	-3.9	-3.9	+0.0	+0.5, -0.5	251.20	-58.1	-57.8	+0.3	+1.0, -998.0
3.98	-5.8	-5.8	+0.0	+0.5, -0.5	316.20	-64.0	-63.7	+0.4	+1.0, -998.0
5.01	-7.8	-7.8	+0.0	+0.5, -0.5	398.10	-70.0	-69.9	+0.1	+1.0, -998.0
6.31	-9.8	-9.9	+0.0	+0.5, -0.5					

Technician: Craig

Test Date: Dec 03, 1999



Larson Davis Model: HVM100; Serial Number: 00103
Certificate of X We Electrical Conformance

This Type 1 Human Vibration Meter was calibrated using a reference 10.0 Hz sine wave at a level of 0.001 Vrms. This calibration level is equivalent to 100.0 dB or 0.10 m/s² (dB reference = 1e-6 m/s²) with an accelerometer sensitivity of 98.1 mV/g. The instrument's frequency response (We weighted, 60 dB gain, Direct input) was then electrically tested as specified in ISO 8041:1990(E).

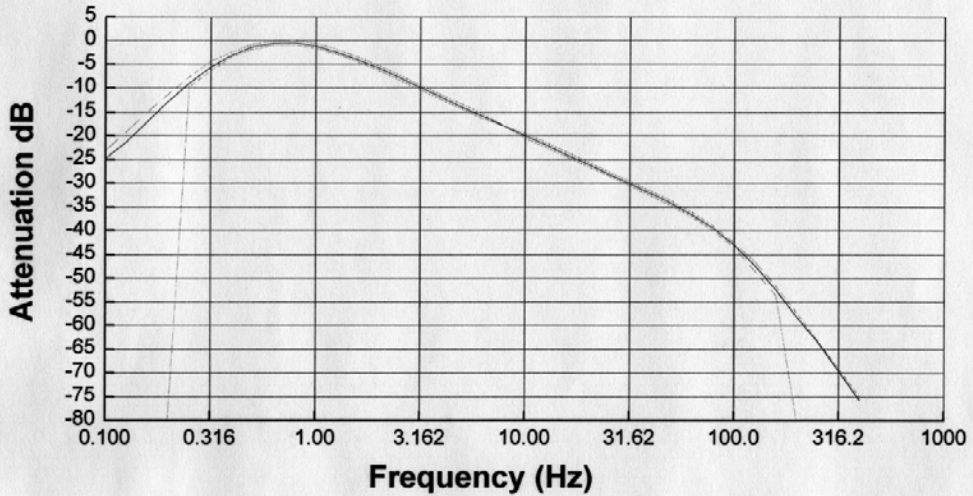

Freq (Hz)	Theor	Measured	Error	LD Tolerance	Freq (Hz)	Theor	Measured	Error	LD Tolerance
0.10	-24.1	-24.7	-0.6	+1.0, -998.0	7.94	-18.0	-18.0	+0.0	+0.0, +0.0
0.13	-20.1	-21.3	-1.2	+1.0, -998.0	10.00	-20.0	-20.0	+0.0	+0.5, -0.5
0.16	-16.1	-17.0	-0.9	+1.0, -998.0	12.59	-22.0	-22.0	+0.0	+0.5, -0.5
0.20	-12.3	-12.8	-0.6	+1.0, -998.0	15.85	-24.0	-24.1	-0.1	+0.5, -0.5
0.25	-8.6	-8.9	-0.3	+1.0, -1.0	19.95	-26.0	-26.1	-0.1	+0.5, -0.5
0.32	-5.4	-5.6	-0.3	+1.0, -1.0	25.12	-28.0	-28.1	-0.1	+0.5, -0.5
0.40	-2.9	-3.0	-0.1	+0.5, -0.5	31.62	-30.0	-30.1	+0.0	+0.5, -0.5
0.50	-1.3	-1.4	-0.1	+0.5, -0.5	39.81	-32.1	-32.2	-0.1	+0.5, -0.5
0.63	-0.6	-0.6	+0.0	+0.5, -0.5	50.12	-34.3	-34.3	+0.0	+0.5, -0.5
0.79	-0.5	-0.5	+0.0	+0.5, -0.5	63.10	-36.6	-36.7	+0.0	+0.5, -0.5
1.00	-1.1	-1.2	-0.1	+0.5, -0.5	79.43	-39.5	-39.5	+0.0	+0.5, -0.5
1.26	-2.3	-2.4	-0.1	+0.5, -0.5	100.00	-43.0	-43.0	+0.0	+0.5, -0.5
1.59	-3.9	-4.0	-0.1	+0.5, -0.5	125.90	-47.5	-47.4	+0.1	+1.0, -1.0
2.00	-5.8	-5.8	+0.0	+0.5, -0.5	158.50	-52.6	-52.5	+0.2	+1.0, -1.0
2.51	-7.8	-7.8	+0.0	+0.5, -0.5	199.50	-58.3	-58.2	+0.1	+1.0, -998.0
3.16	-9.9	-9.9	+0.0	+0.5, -0.5	251.20	-64.1	-63.5	+0.6	+1.0, -998.0
3.98	-11.9	-11.9	+0.0	+0.5, -0.5	316.20	-70.0	-69.7	+0.4	+1.0, -998.0
5.01	-13.9	-14.0	+0.0	+0.5, -0.5	398.10	-76.0	-75.9	+0.2	+1.0, -998.0
6.31	-15.9	-16.0	+0.0	+0.5, -0.5					

Technician: Craig

Test Date: Dec 03, 1999



Larson Davis Model: HVM100; Serial Number: 00109
Certificate of X Wg Electrical Conformance

This Type 1 Human Vibration Meter was calibrated using a reference 79.6 Hz sine wave at a level of 0.001 Vrms. This calibration level is equivalent to 100.0 dB or 0.10 m/s² (dB reference = 1e-6 m/s²) with an accelerometer sensitivity of 98.1 mV/g. The instrument's frequency response (Wg weighted, 60 dB gain, Direct input) was then electrically tested as specified in BS 6841:1987.

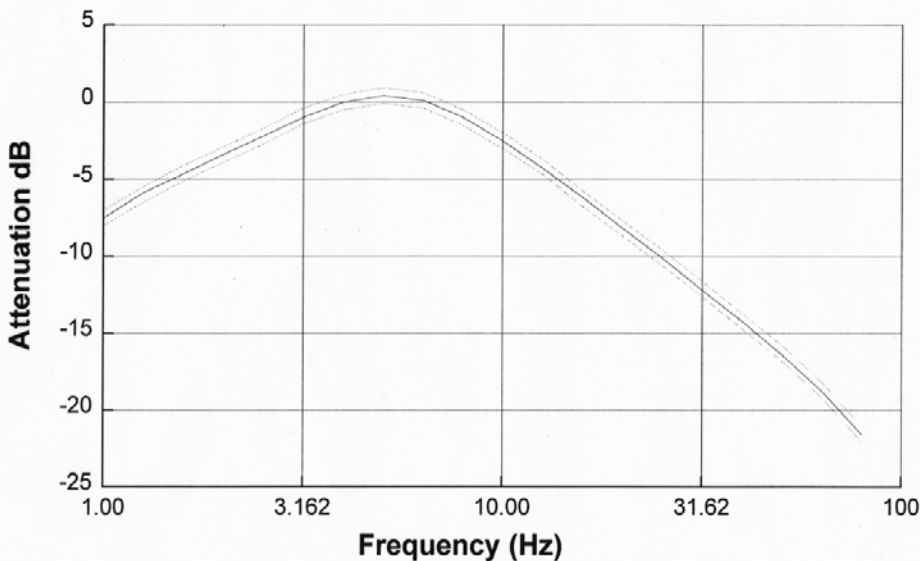

Freq (Hz)	Theor	Measured	Error	LD Tolerance	Freq (Hz)	Theor	Measured	Error	LD Tolerance
1.00	-7.5	-7.5	+0.0	+0.5, -0.5	10.00	-2.5	-2.5	+0.0	+0.5, -0.5
1.26	-6.0	-5.9	+0.1	+0.5, -0.5	12.59	-4.2	-4.3	-0.1	+0.5, -0.5
1.59	-4.6	-4.6	+0.0	+0.5, -0.5	15.85	-6.3	-6.2	+0.1	+0.5, -0.5
2.00	-3.4	-3.4	+0.0	+0.5, -0.5	19.95	-8.2	-8.2	+0.0	+0.5, -0.5
2.51	-2.2	-2.2	+0.0	+0.5, -0.5	25.12	-10.1	-10.1	+0.0	+0.5, -0.5
3.16	-0.9	-1.0	-0.1	+0.5, -0.5	31.62	-12.1	-12.2	-0.1	+0.5, -0.5
3.98	+0.0	+0.0	+0.0	+0.5, -0.5	39.81	-14.2	-14.2	+0.0	+0.5, -0.5
5.01	+0.4	+0.4	+0.0	+0.5, -0.5	50.12	-16.3	-16.4	-0.1	+0.5, -0.5
6.31	+0.1	+0.1	+0.0	+0.5, -0.5	63.10	-18.7	-18.8	-0.1	+0.5, -0.5
7.94	-1.0	-1.0	+0.0	+0.5, -0.5	79.43	-21.6	-21.6	+0.0	+0.5, -0.5

This instrument is in compliance with BS 6841:1987 for Type 1 human vibration meters when used with a Type 1 accelerometer.

Technician: Craig Test Date: Mar 23,2000



Larson Davis Model: HVM100; Serial Number: 00106
Certificate of X Wh Electrical Conformance

This Type 1 Human Vibration Meter was calibrated using a reference 10.0 Hz sine wave at a level of 0.001 Vrms. This calibration level is equivalent to 100.0 dB or 0.10 m/s² (dB reference = 1e-6 m/s²) with an accelerometer sensitivity of 98.1 mV/g. The instrument's frequency response (Wh weighted, 60 dB gain, Direct input) was then electrically tested as specified in ISO 8041:1990(E).

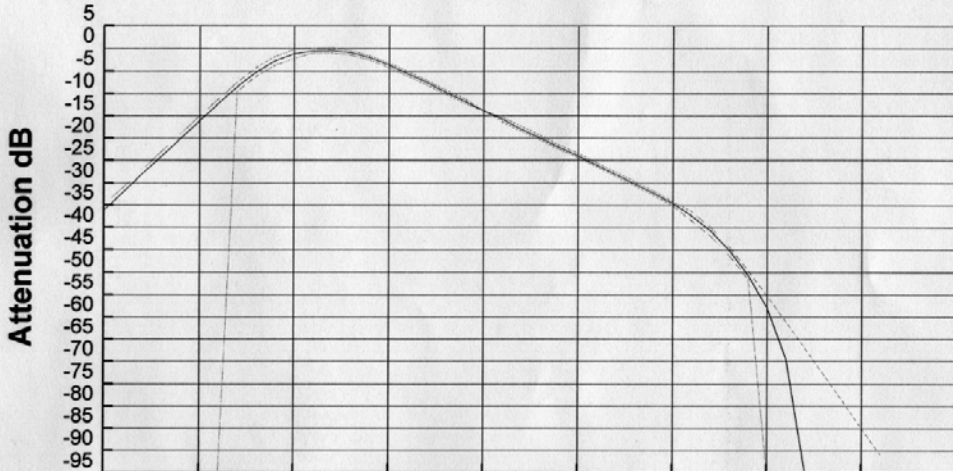

Frequency (Hz)

Freq (Hz)	Theor	Measured	Error	LD Tolerance	Freq (Hz)	Theor	Measured	Error	LD Tolerance
0.79	-36.0	-36.1	-0.1	+1.0, -998.0	100.00	-15.9	-15.9	+0.0	+0.5, -0.5
1.00	-32.0	-32.1	-0.1	+1.0, -998.0	125.90	-17.9	-18.0	+0.0	+0.5, -0.5
1.26	-28.0	-28.0	+0.0	+1.0, -998.0	158.50	-19.9	-20.0	+0.0	+0.5, -0.5
1.59	-24.0	-24.0	+0.0	+1.0, -998.0	199.50	-22.0	-22.0	+0.0	+0.5, -0.5
2.00	-20.0	-20.1	-0.1	+1.0, -998.0	251.20	-24.0	-24.0	+0.0	+0.5, -0.5
2.51	-16.0	-16.1	+0.0	+1.0, -998.0	316.20	-26.0	-26.0	+0.0	+0.5, -0.5
3.16	-12.2	-12.2	+0.0	+1.0, -998.0	398.10	-28.0	-28.1	-0.1	+0.5, -0.5
3.98	-8.5	-8.5	+0.0	+1.0, -1.0	501.20	-30.1	-30.1	-0.1	+0.5, -0.5
5.01	-5.3	-5.3	+0.0	+1.0, -1.0	631.00	-32.2	-32.3	+0.0	+0.5, -0.5
6.31	-2.8	-2.8	+0.0	+1.0, -1.0	794.30	-34.6	-34.6	+0.0	+0.5, -0.5
7.94	-1.2	-1.2	+0.0	+1.0, -1.0	1000.00	-37.4	-37.4	+0.0	+1.0, -1.0
10.00	-0.4	-0.5	+0.0	+0.5, -0.5	1259.00	-41.0	-40.8	+0.2	+1.0, -1.0
12.59	-0.4	-0.4	+0.0	+0.5, -0.5	1585.00	-45.4	-45.2	+0.2	+1.0, -1.0
15.85	-1.0	-1.0	+0.0	+0.5, -0.5	1995.00	-50.6	-50.7	-0.1	+1.0, -1.0
19.95	-2.1	-2.1	+0.0	+0.5, -0.5	2512.00	-56.2	-58.0	-1.8	+1.0, -998.0
25.12	-3.8	-3.8	+0.0	+0.5, -0.5	3162.00	-62.1	-69.5	-7.4	+1.0, -998.0
31.62	-5.7	-5.7	+0.0	+0.5, -0.5	3981.00	-68.0	-112.3	-44.3	+1.0, -998.0
39.81	-7.7	-7.7	+0.0	+0.5, -0.5	5012.00	-74.0	-105.1	-31.1	+1.0, -998.0
50.12	-9.8	-9.8	+0.0	+0.5, -0.5	6310.00	-80.0	-111.2	-31.3	+1.0, -998.0
63.10	-11.8	-11.9	-0.1	+0.5, -0.5	7943.00	-86.0	-106.2	-20.3	+1.0, -998.0
79.43	-13.9	-13.9	+0.0	+0.0, +0.0	10000.00	-92.0	-103.1	-11.1	+1.0, -998.0

Technician: Craig

Test Date: Dec 08, 1999



Larson Davis Model: HVM100; Serial Number: 00103
Certificate of X Wj Electrical Conformance

This Type 1 Human Vibration Meter was calibrated using a reference 10.0 Hz sine wave at a level of 0.001 Vrms. This calibration level is equivalent to 100.0 dB or 0.10 m/s² (dB reference = 1e-6 m/s²) with an accelerometer sensitivity of 98.1 mV/g. The instrument's frequency response (Wj weighted, 60 dB gain, Direct input) was then electrically tested as specified in ISO 8041:1990(E).

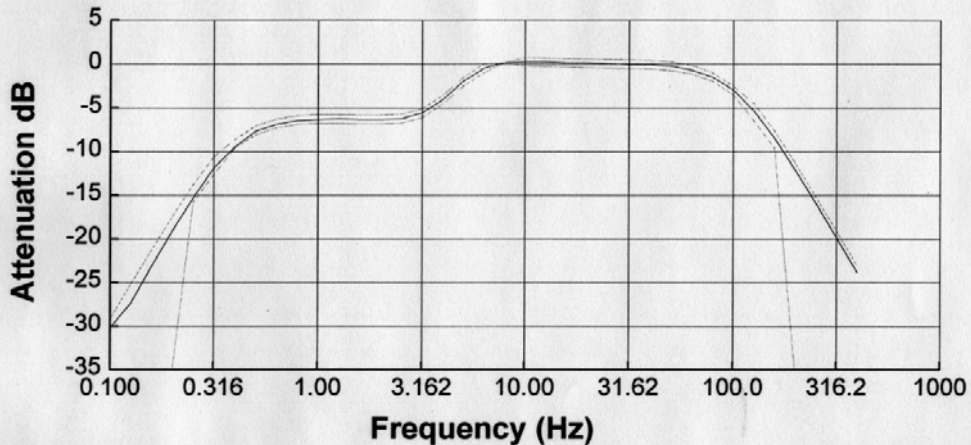

Freq (Hz)	Theor	Measured	Error	LD Tolerance	Freq (Hz)	Theor	Measured	Error	LD Tolerance
0.10	-30.2	-30.2	+0.0	+1.0, -998.0	7.94	+0.1	+0.1	+0.0	+0.0, +0.0
0.13	-26.2	-27.4	-1.2	+1.0, -998.0	10.00	+0.3	+0.2	+0.0	+0.5, -0.5
0.16	-22.3	-23.1	-0.8	+1.0, -998.0	12.59	+0.2	+0.2	+0.0	+0.5, -0.5
0.20	-18.4	-19.0	-0.6	+1.0, -998.0	15.85	+0.2	+0.1	+0.0	+0.5, -0.5
0.25	-14.8	-15.3	-0.5	+1.0, -1.0	19.95	+0.1	+0.1	+0.0	+0.5, -0.5
0.32	-11.6	-11.9	-0.3	+1.0, -1.0	25.12	+0.1	+0.0	+0.0	+0.5, -0.5
0.40	-9.1	-9.5	-0.3	+0.5, -0.5	31.62	+0.0	-0.1	-0.1	+0.5, -0.5
0.50	-7.6	-7.7	-0.1	+0.5, -0.5	39.81	-0.1	-0.1	+0.0	+0.5, -0.5
0.63	-6.8	-6.9	-0.1	+0.5, -0.5	50.12	-0.3	-0.3	+0.0	+0.5, -0.5
0.79	-6.4	-6.5	-0.1	+0.5, -0.5	63.10	-0.6	-0.7	+0.0	+0.5, -0.5
1.00	-6.3	-6.4	-0.1	+0.5, -0.5	79.43	-1.5	-1.5	+0.0	+0.5, -0.5
1.26	-6.3	-6.3	+0.0	+0.5, -0.5	100.00	-3.0	-3.0	+0.1	+0.5, -0.5
1.59	-6.3	-6.3	+0.0	+0.5, -0.5	125.90	-5.4	-5.4	+0.1	+1.0, -1.0
2.00	-6.3	-6.4	+0.0	+0.5, -0.5	158.50	-8.6	-8.5	+0.2	+1.0, -1.0
2.51	-6.2	-6.3	+0.0	+0.5, -0.5	199.50	-12.3	-12.1	+0.2	+1.0, -998.0
3.16	-5.6	-5.6	+0.0	+0.5, -0.5	251.20	-16.1	-15.9	+0.3	+1.0, -998.0
3.98	-4.1	-4.1	+0.0	+0.5, -0.5	316.20	-20.0	-19.9	+0.2	+1.0, -998.0
5.01	-2.0	-2.0	+0.0	+0.5, -0.5	398.10	-24.0	-23.9	+0.2	+1.0, -998.0
6.31	-0.5	-0.5	+0.0	+0.5, -0.5					

Technician: Craig

Test Date: Dec 03, 1999



Larson Davis Model: HVM100; Serial Number: 00103
Certificate of X Wk Electrical Conformance

This Type 1 Human Vibration Meter was calibrated using a reference 10.0 Hz sine wave at a level of 0.001 Vrms. This calibration level is equivalent to 100.0 dB or 0.10 m/s² (dB reference = 1e-6 m/s²) with an accelerometer sensitivity of 98.1 mV/g. The instrument's frequency response (Wk weighted, 60 dB gain, Direct input) was then electrically tested as specified in ISO 8041:1990(E).

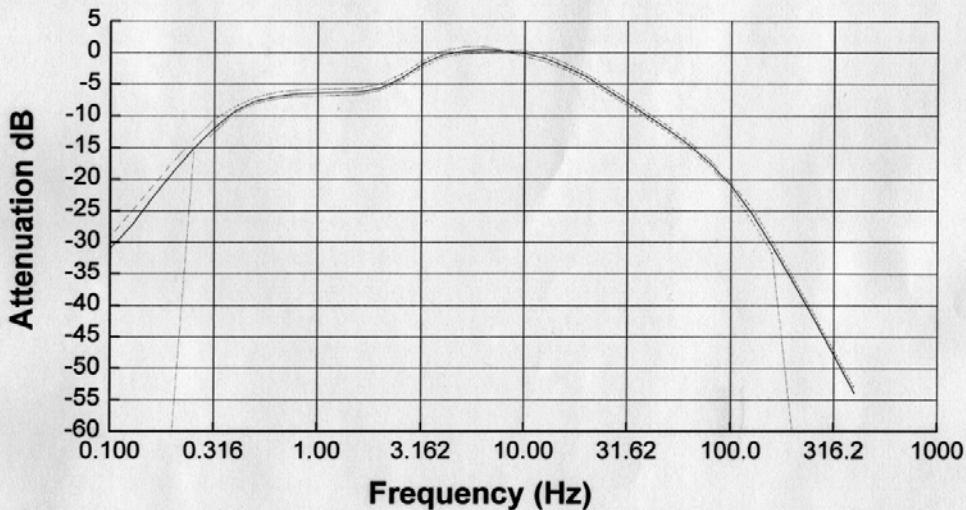

Freq (Hz)	Theor	Measured	Error	LD Tolerance	Freq (Hz)	Theor	Measured	Error	LD Tolerance
0.10	-30.1	-31.0	-0.9	+1.0, -998.0	7.94	+0.3	+0.3	+0.0	+0.0, +0.0
0.13	-26.1	-27.4	-1.2	+1.0, -998.0	10.00	-0.1	-0.1	+0.0	+0.5, -0.5
0.16	-22.2	-23.0	-0.8	+1.0, -998.0	12.59	-0.9	-0.9	+0.0	+0.5, -0.5
0.20	-18.4	-18.9	-0.5	+1.0, -998.0	15.85	-2.2	-2.2	+0.0	+0.5, -0.5
0.25	-14.7	-15.1	-0.4	+1.0, -1.0	19.95	-3.9	-3.9	+0.0	+0.5, -0.5
0.32	-11.6	-11.9	-0.3	+1.0, -1.0	25.12	-5.8	-5.9	+0.0	+0.5, -0.5
0.40	-9.1	-9.3	-0.2	+0.5, -0.5	31.62	-7.9	-7.9	+0.0	+0.5, -0.5
0.50	-7.6	-7.7	-0.1	+0.5, -0.5	39.81	-10.0	-10.0	+0.0	+0.5, -0.5
0.63	-6.8	-6.9	-0.1	+0.5, -0.5	50.12	-12.2	-12.3	-0.1	+0.5, -0.5
0.79	-6.4	-6.6	-0.1	+0.5, -0.5	63.10	-14.6	-14.7	-0.1	+0.5, -0.5
1.00	-6.3	-6.4	+0.0	+0.5, -0.5	79.43	-17.5	-17.5	+0.0	+0.5, -0.5
1.26	-6.3	-6.3	+0.0	+0.5, -0.5	100.00	-21.0	-21.0	+0.1	+0.5, -0.5
1.59	-6.1	-6.2	-0.1	+0.5, -0.5	125.90	-25.5	-25.4	+0.1	+1.0, -1.0
2.00	-5.5	-5.6	-0.1	+0.5, -0.5	158.50	-30.7	-30.6	+0.1	+1.0, -1.0
2.51	-4.0	-4.0	-0.1	+0.5, -0.5	199.50	-36.3	-36.1	+0.2	+1.0, -998.0
3.16	-1.9	-1.9	+0.0	+0.5, -0.5	251.20	-42.2	-42.0	+0.2	+1.0, -998.0
3.98	-0.3	-0.4	-0.1	+0.5, -0.5	316.20	-48.1	-47.9	+0.2	+1.0, -998.0
5.01	+0.3	+0.3	+0.0	+0.5, -0.5	398.10	-54.1	-53.9	+0.2	+1.0, -998.0
6.31	+0.5	+0.4	+0.0	+0.5, -0.5					

Technician: Craig

Test Date: Dec 03, 1999



Larson Davis Model: HVM100; Serial Number: 00103
Certificate of X Ws Electrical Conformance

This Type 1 Human Vibration Meter was calibrated using a reference 10.0 Hz sine wave at a level of 0.001 Vrms. This calibration level is equivalent to 100.0 dB or 0.10 m/s² (dB reference = 1e-6 m/s²) with an accelerometer sensitivity of 98.1 mV/g. The instrument's frequency response (Ws weighted, 60 dB gain, Direct input) was then electrically tested as specified in ISO 8041:1990(E).

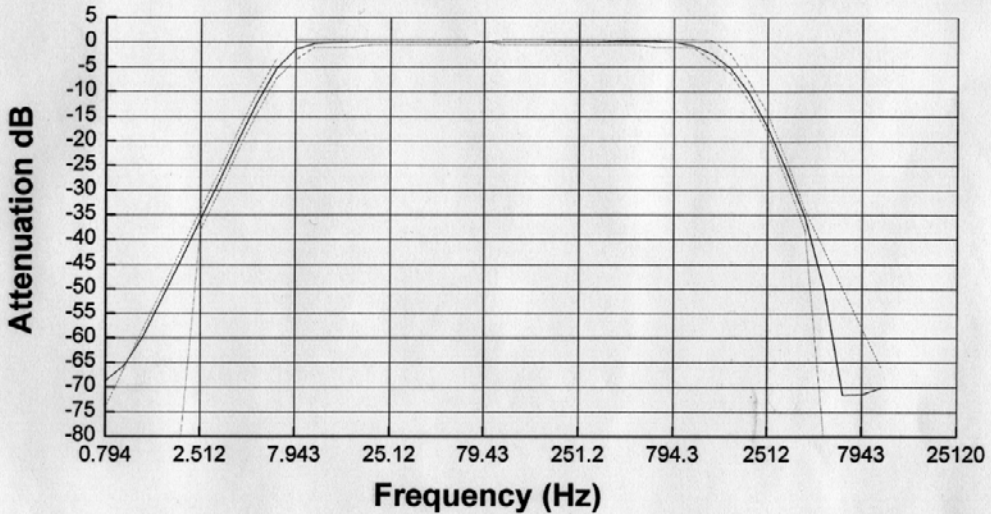

Freq (Hz)	Theor	Measured	Error	LD Tolerance	Freq (Hz)	Theor	Measured	Error	LD Tolerance
					100.00	+0.0	+0.0	+0.0	+0.5, -0.5
					125.90	+0.0	+0.0	+0.0	+0.5, -0.5
1.26	-60.0	-59.5	+0.5	+2.0, -998.0	158.50	+0.0	+0.0	+0.0	+0.5, -0.5
1.59	-52.0	-51.8	+0.2	+2.0, -998.0	199.50	+0.0	+0.1	+0.1	+0.5, -0.5
2.00	-44.0	-43.9	+0.1	+2.0, -998.0	251.20	+0.0	+0.1	+0.1	+0.5, -0.5
2.51	-36.0	-35.8	+0.2	+2.0, -2.0	316.20	+0.0	+0.1	+0.1	+0.5, -0.5
3.16	-28.0	-27.8	+0.2	+2.0, -2.0	398.10	+0.0	+0.2	+0.2	+0.5, -0.5
3.98	-19.9	-19.8	+0.1	+2.0, -2.0	501.20	+0.0	+0.2	+0.2	+0.5, -0.5
5.01	-12.2	-12.1	+0.1	+2.0, -2.0	631.00	+0.0	+0.2	+0.2	+0.5, -1.0
6.31	-5.3	-5.3	+0.0	+2.0, -2.0	794.30	+0.0	+0.0	+0.0	+0.5, -1.0
7.94	-1.5	-1.4	+0.1	+2.0, -2.0	1000.00	+0.0	-0.7	-0.7	+0.5, -1.0
10.00	+0.0	-0.3	-0.3	+0.5, -1.0	1259.00	-1.7	-2.3	-0.6	+2.0, -2.0
12.59	+0.0	-0.1	-0.1	+0.5, -1.0	1585.00	-4.3	-5.3	-1.0	+2.0, -2.0
15.85	+0.0	+0.0	+0.0	+0.5, -1.0	1995.00	-9.8	-10.2	-0.4	+2.0, -2.0
19.95	+0.0	+0.0	+0.0	+0.5, -0.5	2512.00	-16.3	-17.2	-0.9	+2.0, -2.0
25.12	+0.0	+0.0	+0.0	+0.5, -0.5	3162.00	-25.8	-25.8	+0.0	+2.0, -2.0
31.62	+0.0	+0.0	+0.0	+0.5, -0.5	3981.00	-36.0	-35.5	+0.5	+2.0, -2.0
39.81	+0.0	+0.0	+0.0	+0.5, -0.5	5012.00	-44.0	-49.8	-5.8	+2.0, -998.0
50.12	+0.0	+0.0	+0.0	+0.5, -0.5	6310.00	-52.0	-71.5	-19.5	+2.0, -998.0
63.10	+0.0	+0.0	+0.0	+0.5, -0.5	7943.00	-60.0	-71.5	-11.5	+2.0, -998.0
79.43	+0.0	+0.0	+0.0	+0.0, +0.0	10000.00	-68.0	-70.1	-2.1	+2.0, -998.0

Technician: Craig Test Date: Dec 03, 1999

E

Miscellaneous Information

This appendix contains additional information about the AC and DC outputs and measurement ranges for Hand-arm and Whole Body measurements.

DC Output Calibration

Since the sensitivity will vary a little from unit to unit, the DC output sensitivity should be calibrated, or measured, before it is used. Follow these steps to measure the DC output sensitivity.

Step 1 Calibrate the HVM100 for the accelerometer that will be used.

Step 2 Setup the HVM100 with the following settings:

- a. Operating Mode = Vibration
- b. Averaging = Slow
- c. Auto Store = Off
- d. Weighting = Fc (all channels)
- e. Integration = None
- f. AC/DC Output = DC: rms (all channels)

Step 3 The gain setting depends upon the sensitivity of the accelerometer being used. The table below shows the appropriate gain setting (for all chan-

nels) based on the sensitivity of the accelerometer. The values in the table assume that a calibrator that vibrates 1g rms and 159.15 Hz, will be used.

Gain setting for various accelerometer sensitivities

	1 mV/g	10 mV/g	100 mV/g
Gain	60 dB	40 dB	20 dB

- Step 4** Connect a DC rms voltmeter to the DC output.
- Step 5** Turn on the calibrator and start the HVM100 running. The HVM100 should display an Arms level of 1 g.
- Step 6** Note the voltage reading on the voltmeter. The voltage corresponds to 1 g rms of acceleration. The voltage will typically be about 600 mV for a 1 g rms input signal.
- Step 7** Stop and Reset the HVM100. Reduce the calibrator's output level to 0.1 g rms. If this isn't possible, change the HVM100's weighting to Wh (Hand-Arm mode). The Wh weighting will attenuate the calibrator's signal to 0.1 g rms (an attenuation of 20.0 dB).
- Step 8** Turn on the calibrator and start the HVM100 running. The HVM100 should display an Arms level of 0.1 g.
- Step 9** Note the voltage reading on the voltmeter. The voltage corresponds to 0.1 g rms of acceleration. The voltage will typically be about 500 mV for a 0.1 g rms input signal.
- Step 10** The DC output uses a logarithmic scale. The formula for the sensitivity is:

$$\text{DC output sensitivity} = \frac{(\text{voltage at } 1\text{g}) - (\text{voltage at } 0.1\text{g})}{20 \text{ dB}}$$

NOTE: Using the typical values of 600 mV (1g) and 500 mV (0.1g), the calculated sensitivity would be 5 mV/dB. Note that the sensitivity is the same regardless of the DC output setting (i.e. rms, sum, min, max, peak).

Step 11 To convert a DC output voltage to units of g, use the following formula:

$$g_{output} = 20 \cdot 10^{(present\ voltage - voltage\ 1g) / (DC\ output\ sensitivity)}$$

NOTE: The formula is the same regardless of whether the DC output is being used to measure rms, min, max, or peak acceleration. The only difference is the reference voltage (i.e. the voltage @ 1g). If the DC output is set for rms, min, or max, the reference voltage is the voltage @ 1g rms. If the DC output is set to peak, the reference voltage is the voltage @ 1g peak.

AC/DC Outputs

DC Output

For all of the Analog AC and Analog DC outputs, the output impedance of the HVM100 is 475 ohms. For minimal error, connect to instruments with an input impedance of greater than 100,000 ohms when making AC or DC output measurements.

DC output sensitivity = 5 mV/dB (typical). The level varies between 0 Vdc to 1.0 Vdc.

Since the sensitivity is fixed at approximately 5 mV/dB, the DC output signal is not affected by the user's selection for "display units" or the user's selection of the dB reference value (i.e. 10^{-6} m/s² or 10^{-5} m/s²).

The DC output is tied directly to the rms, min, max, and peak values measured by the HVM100; therefore, the DC output signal is not available if the instrument has been RESET. If the instrument is in a RESET condition, the DC output level will be at approximately -300 mV.

The DC output range covers the entire measurement range of the HVM100. In other words, the DC output signal level is not affected by the gain settings.

AC Output

The maximum signal produced by the AC output is approximately 0.5 Vrms. However, the maximum input level measurable by the HVM100 is approximately 5.0 Vrms (a difference of 20 dB). Therefore, in order for the HVM100's AC output to function properly with each range (i.e. gain settings of 0, 20, 40, and 60 dB), the HVM100's gain settings also affect the AC output signals. For example, with a gain setting of 0 dB, the HVM100 can measure input signals as large as 5.0 Vrms. Since these signals exceed the AC output range, they are attenuated to 0.5 Vrms (a gain of -20 dB) so that they can be reproduced by the AC output. The table below shows the correlation between input signal level and AC output signal level.

AC Output Gain

RANGE (Gain Setting)	INPUT Maximum Signal Level (Vrms)	AC OUTPUT Gain	AC OUTPUT Maximum Signal Level (Vrms)
0 dB	5.0	-20 dB	0.5 Vrms
20 dB	0.5	0 dB	0.5 Vrms
40 dB	0.05	+20 dB	0.5 Vrms
60 dB	0.005	+40 dB	0.5 Vrms

Typical Measurement Ranges for Hand-Arm and Whole Body Measurements

ICP® Accelerometers

Hand-Arm (Wh) and Whole Body (Wm, Wc, Wd, We, Wb, Wf, Wk)

1 mV/g			10 mV/g		100 mV/g	
Gain	RMS Range g	Peak Range g	RMS Range g	Peak Range g	RMS Range g	Peak Range g
0 dB	5-5000	90-7000	0.5-500	9-700	0.05-50	0.9-70
20 dB	0.5-500	9-700	0.05-50	0.9-70	0.005-5	0.09-7
40 dB	0.05-50	0.9-70	0.005-5	0.09-7	0.0005-0.5	0.009-0.7

Hand-Arm (Wh)

1 mV/g			10 mV/g		100 mV/g	
Gain	RMS Range g	Peak Range g	RMS Range g	Peak Range g	RMS Range g	Peak Range g
60 dB	0.01-5	0.2-7	0.001-0.5	0.02-0.7	0.0001-0.05	0.002-0.07

Whole-Body (Wm, Wg)

1 mV/g			10 mV/g		100 mV/g	
Gain	RMS Range g	Peak Range g	RMS Range g	Peak Range g	RMS Range g	Peak Range g
60 dB	0.02-5	0.3-7	0.002-0.5	0.03-0.7	0.0002-0.05	0.003-0.07

Whole-Body (Wc, Wd, We)

1 mV/g			10 mV/g		100 mV/g	
Gain	RMS Range g	Peak Range g	RMS Range g	Peak Range g	RMS Range g	Peak Range g
60 dB	0.05-5	0.8-7	0.005-0.5	0.08-0.7	0.0005-0.05	0.008-0.07

Whole-Body (Wb, Wf, Wk)

1 mV/g			10 mV/g		100 mV/g	
Gain	RMS Range g	Peak Range g	RMS Range g	Peak Range g	RMS Range g	Peak Range g
60 dB	0.03-5	0.5-7	0.003-0.5	0.05-0.7	0.0003-0.05	0.005-0.07

Notes

1. The data in the above tables was calculated using the dBuV range data in the HVM100 User Manual.
2. The data in the above table was obtained by electrically testing the HVM100.
3. The data is based on ideal accelerometers (the noise floor and upper limit of the accelerometer were not considered).

Typical Measurement Ranges for General Purpose Vibration Measurements

ICP® Accelerometers

Fa, Fb, Fc, Ws Weighting

1 mV/g			10 mV/g		100 mV/g	
Gain	RMS Range g	Peak Range g	RMS Range g	Peak Range g	RMS Range g	Peak Range g
0 dB	5-5000	90-7000	0.5-500	9-700	0.05-50	0.9-70
20 dB	0.5-500	9-700	0.05-50	0.9-70	0.005-5	0.09-7

Fa Weighting

1 mV/g			10 mV/g		100 mV/g	
Gain	RMS Range g	Peak Range g	RMS Range g	Peak Range g	RMS Range g	Peak Range g
40 dB	0.06-50	1.1-70	0.006-5	0.11-7	0.0006-0.5	0.011-0.7
60 dB	0.04-5	0.8-7	0.004-0.5	0.08-0.7	0.0004-0.05	0.008-0.07

Fb, Fc, Ws Weighting

1 mV/g			10 mV/g		100 mV/g	
Gain	RMS Range g	Peak Range g	RMS Range g	Peak Range g	RMS Range g	Peak Range g
40 dB	0.1-50	1.8-70	0.01-5	0.18-7	0.001-0.5	0.018-0.7
60 dB	0.04-5	0.8-7	0.004-0.5	0.08-0.7	0.0004-0.05	0.008-0.07

Notes

1. The data in the above tables was calculated using the dBuV range data in the HVM100 User Manual.
2. The data in the above table was obtained by electrically testing the HVM100.
3. The data is based on ideal accelerometers (the noise floor and upper limit of the accelerometer were not considered).

F

Serial Number Backup

Setting Serial Number Backup

The first time the HVM is booted up after having the serial number programmed, the code will detect that the backup copies are blank and set them. The following display will appear at this time.

```
Setting Backup  
SN copies...
```

This should happen before the unit leaves Larson Davis, and the only time a user will see this message is if the backup copies are cleared. After this is done, the unit will continue to operate as normal. This display lasts 3 seconds.

Serial Number Reset

If for some reason the serial number gets corrupted, the code will detect the problem and reset it from the backup copies (the two backups need to match each other). The following display will appear at this time.

```
Serial Number  
Reset to Backup.
```

Press the reset key to proceed. After this is done, the unit will continue to operate as normal. This display lasts 3 seconds.

Failure of Serial Number Reset

Note: there is an extremely low probability that this condition will occur. However, it is documented here for your reference.

If there is not a two-of-three agreement between any of the serial number copies, the following two displays will appear in sequence for three seconds.

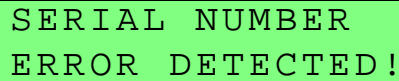

```
SERIAL NUMBER  
ERROR DETECTED!
```

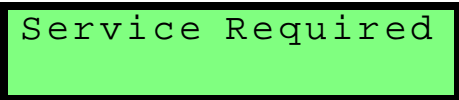

```
Service Required
```

Following this, the meter will continue to boot as normal, EXCEPT that none of the purchased options will be available. Technical support from Larson Davis is required to remedy this situation.